

LigoWave

Product Overview

Content

Solutions

Operators	2
Enterprise	3
Industrial	4
Security	5

DLB series

Product summary (2 GHz outdoor)	7
Product summary (5 GHz outdoor)	8
Product comparison	9

LigoPTP series

LigoPTP RapidFire	11
Product summary	12
Product comparison	13

NFT series

Product summary	15
-----------------	----

Accessories

Product summary	16
-----------------	----

LigoWave software

WNMS	18
WNMS Cloud	19
WNMS Mobile	19
Installer App	20
LinkCalc	20

Operators

Last-mile and backhaul solutions for Internet service providers and operators



Challenges:

No infrastructure for connectivity in rural and suburban areas, noisy unlicensed band and high-throughput demanding services.

Solutions:



Variety of devices

LigoWave's product line offers a wide variety of products designed to operate in point-to-point and point-to-multipoint scenarios for various distances, with differing capacities and at price levels that allow appropriate investment for each location. A choice of unique devices for different scenarios and applications provides end-users with the utmost flexibility.



Proprietary protocols

W-Jet and iPoll maximize the performance of LigoWave's PTP and PTMP devices even in RF intense environments, to ensure higher bandwidth, higher packet per second rate, and low, stable latency with no distance limitation. Automatic channel selection and automatic transmit power control mechanisms allow avoiding noisy channels and optimizing the RF output power to maximize performance and minimize undesirable noise emissions. The reliability and solid performance of these proprietary protocols ensure service provider success.

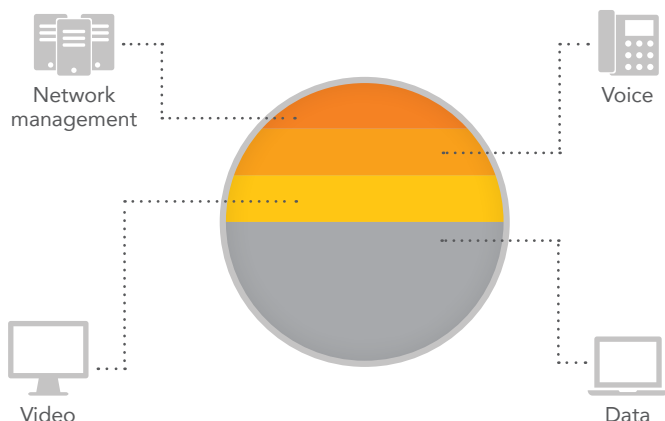

Advanced QoS

QoS allows prioritizing real time voice and video data and allows delivering triple play services to end users more effectively. Impressive performance results are achieved when QoS is combined with the high packet per second rate on LigoWave devices.

Enterprise

A range of wireless devices delivering Internet connectivity to any type of enterprise in a private or governmental sector

Challenges:

Easy setup, high security level, different types of data transmitted over the network and long-distance high-throughput links.

Solutions:

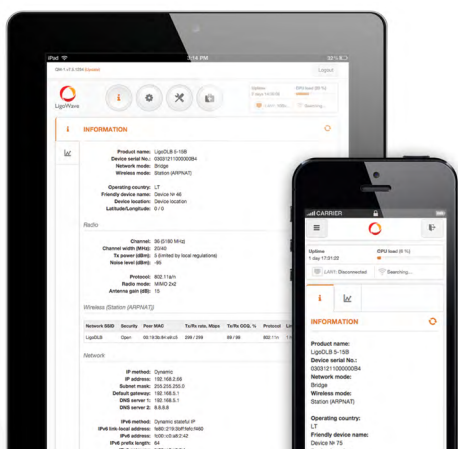

Powerful OS

The operating system embedded in LigoWave devices is straightforward and intuitive. Each device group has specifically chosen functionality that is necessary for a particular application. The fast and responsive HTML 5 user interface allows accessing wireless equipment not only with a laptop or regular PC, but also with smart phones and tablets.

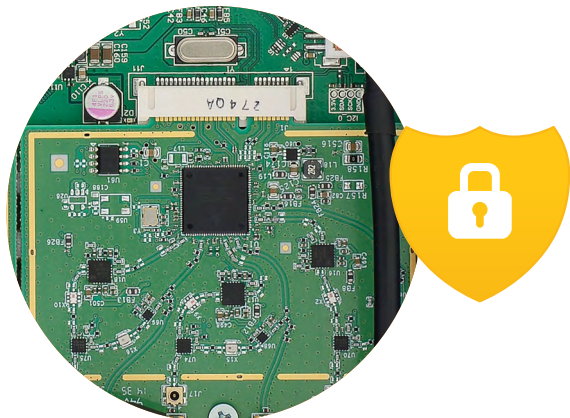

Reliable security mechanisms

Hardware based AES 128 encryption, which is compatible with a FIPS-197 standard, allows protecting sensitive data and is suitable even for banking or governmental networks. Hidden SSID, HTTPS for secure user interface access, SSH for secure command line management and SNMP v3 for secure data collection and monitoring make LigoWave devices ideal for enterprise networks.



50+
kilometer

High capacity links

High throughput over long distances can be achieved with high output power coupled with high gain antennas, enabling the transmission of hundreds of megabits over 50+ KM (30+ mile) links. There are multiple models equipped with professional N-connectors that can be used with a variety of external, high gain antennas to achieve remarkable results.

Industrial

Solid and carrier-grade LigoPTP series devices are ideal to cater the needs of industrial applications like oil and gas, mining camps, energy companies and other

Challenges:

Severe climate conditions, reliable transmission of mission critical data and security.

Solutions:

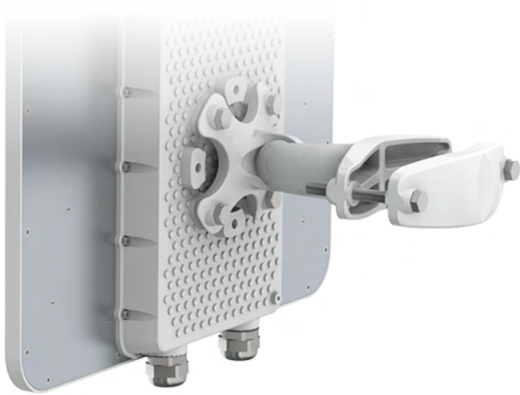

Professional hardware design

LigoWave's hardware is designed according to specific standards that are critical for industrial applications (ATEX and others). IP-6x standard rated enclosures and professional mounting brackets make LigoWave devices the right choice for industrial applications. The integrated surge protection systems are designed to be two times higher than the top class IEC standard requirements in order to survive extreme voltage surges and lightning.

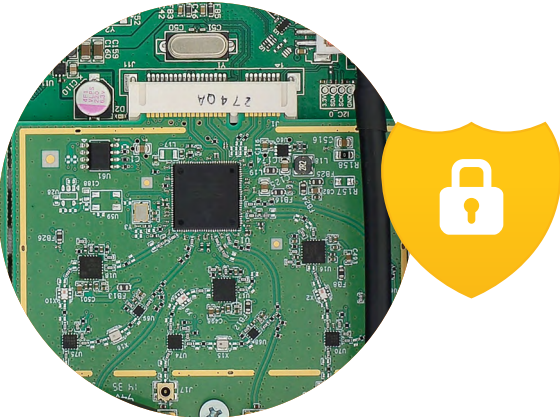

Reliable security mechanisms

Security is an important topic for enterprise networks. Hardware based AES 128 encryption, which is compatible with a FIPS-197 standard, allows protecting sensitive data and is suitable even for banking or governmental networks. Hidden SSID, HTTPS for secure user interface access, SSH for secure command line management and SNMP v3 for secure data collection and monitoring make LigoWave devices ideal for the industrial networks.

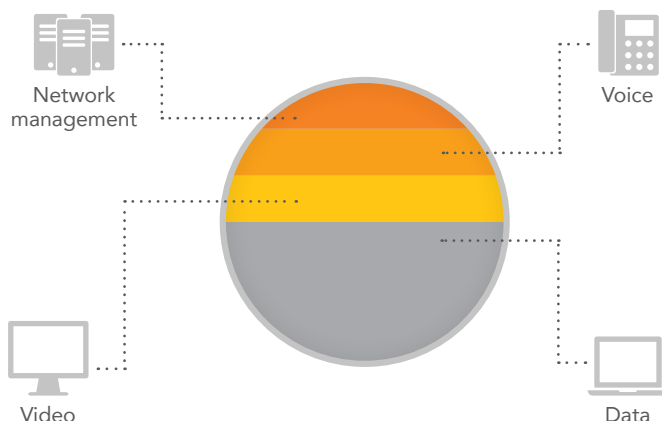

Quality of service (QoS)

QoS prioritizes mission critical data and LigoWave's hardware based QoS does not generate additional CPU load, thereby leaving the resources for other processes such as high speed packet handling.

Security

High throughput, secure and reliable data transmission make LigoWave devices ideal for a real-time data transmission



Challenges:

High capacity, reliable mission critical data transmission and a harsh weather outdoor environment.

Solutions:



Professional software functionality

W-Jet and iPoll allow maximizing performance of LigoWave's PTP and PTMP devices even in RF intense environments, ensuring higher bandwidth, higher packet per second rate, and low and stable latency with no distance limitation. Automatic channel selection and automatic transmit power control mechanisms allow avoiding noisy channels and optimize the RF output power to maximize performance and minimize undesirable noise emissions.

- 1 Network management
- 2 Voice
- 3 Video
- 4 Data



Quality of service (QoS)

QoS prioritizes mission critical data. Security providers can set the highest priority to video data over other types of traffic to ensure the lowest possible latency and steady display of video signals.

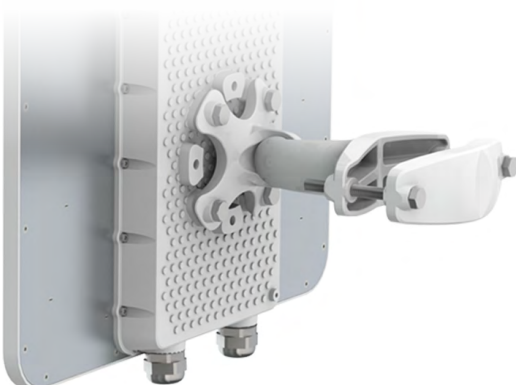

Professional hardware design

IP-6x standard rated enclosures and professional mounting brackets allow LigoWave devices to be installed wherever security devices need wireless connectivity. The carrier grade surge protection systems are designed to be two times higher than the top class IEC standard requirements in order to survive extreme voltage surges and lightning.



DLB series

LigoWave's DLB series devices are a new generation of PTMP products dedicated for the last-mile and light backhaul applications. The software flexibility to operate in an access point or client mode makes DLB series equipment suitable for a wide range of applications in multiple markets including service providers, security companies doing video surveillance, enterprises doing hotspot installations and many more. The powerful proprietary data transmission protocol, iPoll 2, ensures smooth and solid performance in the unlicensed 2.4 and 5 GHz bands while achieving high (170 Mbps) throughput and outstanding (90,000) PPS rate, which far exceeds any of the competition. A variety of models including base-stations and client devices make this product line ideal for Internet service providers and operators running their networks in unlicensed bands. The operating system uses the latest HTML 5 technology making the UI flexible to fit to any screen size and easy to use for smooth and fast configurations. The high-quality radio design, professional hardware, a powerful and flexible operating system, and a comprehensive network management system (WNMS) are key factors for differentiating the DLB series products in the wireless broadband market.

Product summary (2 GHz outdoor)



Product	DLB 2-90	DLB 2	DLB 2-14	DLB 2-9B	DLB Propeller 2	DLB 2-9
Role description	Extremely cost effective base station with an integrated high gain 90° sector antenna	High power multipurpose device with 2 external N-connectors	Powerful client device with an integrated high gain antenna for mid-range links	Small size client device for high capacity short distance links	Unique client device with a mechanical antenna switching mechanism	Smallest, but yet powerful and the most cost effective client device
Radio						
Frequency	2.402 – 2.492 GHz					
Channel size	5, 10, 20, 40 MHz					
Stream	MIMO 2x2					
Wireless protocol	Proprietary iPoll 2 or standard 802.11n					
Operating mode	Point to Multi Point					
Max output power	31 dBm*				28 dBm*	28 dBm*
Receive sensitivity at 20 MHz channel	-95 dBm +/-2 dB @BPSK -91 dBm +/-2 dB @QPSK -83 dBm +/-2 dB @16QAM -78 dBm +/- 2 dB @64QAM					
Network						
Ethernet interface	10/100 Base-T					
Aggregated data throughput	170 Mbps					
Antenna						
Gain	16 dBi (dual POL)	-	14 dBi (dual POL)	9 dBi (dual POL)	11 dBi (dual POL)	9 dBi (dual POL)
Beamwidth horizontal	100 deg.	-	34 deg.	55 deg.	70 or 35 deg.	55 deg.
Beamwidth vertical	30 deg.	-	36 deg.	62 deg.	35 or 70 deg.	62 deg.
Mounting						
Pole diameter	2.5 – 5 cm 1 – 2 in	3.5 – 6 cm 1.3 – 2.3 in	2 – 5 cm 0.8 – 2 in	3.5 – 6 cm 1.3 – 2.3 in	3 – 7 cm 1.2 – 2.7 in	2 – 7 cm 0.8 – 2.7 in
Tilting	+10 /- 30 degrees	-	+/- 40 degrees	-	-	-
Powering						
Method	Passive PoE; 4,5 pin (+) and 7,8 pin (-)					
Input voltage	12 – 24 V					
Power consumption	4.5 W					

* Country dependent

Product summary (5 GHz outdoor)



Product	DLB 5-90	DLB 5	DLB 5-20	DLB 5-15B	DLB 5-15	DLB Propeller 5	DLB Mach 5	DLB Echo 5	DLB Echo 5D
Role description	Extremely cost effective base station with an integrated high gain 90° sector antenna	High power multipurpose device with 2 external N-connectors	Powerful client device with an integrated high gain antenna for mid-range links	Small size device for high capacity short distance links	Smallest, but yet powerful and the most cost effective client device	Unique client device with a mechanical antenna characteristics switching mechanism	High capacity and high performance device ideal for mid to long range distance links	Professional wireless device suitable for short to medium distances	Long-range and high-gain wireless device suitable to use with any standard offset satellite dish antenna
Radio									
Frequency	5.150 - 5.850 GHz (FCC 5.150 - 5.250 and 5.725 - 5.850 GHz)								
Channel size	5, 10, 20, 40 MHz								
Stream	MIMO 2x2								
Wireless protocol	Proprietary iPoll 2 or standard 802.11n								
Operating mode	Point to Multi Point								
Max output power	29 dBm*								
Receive sensitivity at 20 MHz channel	-97 dBm +/- 2 dB @BPSK -93 dBm +/- 2 dB @QPSK -85 dBm +/- 2 dB @16QAM -75 dBm +/- 2 dB @64QAM								
Network									
Ethernet interface	10/100 Base-T								
Aggregated data throughput	170 Mbps								
Antenna									
Gain	18 dBi (dual POL)	-	20 dBi (dual POL)	15 dBi (dual POL)	15 dBi (dual POL)	15 dBi (dual POL)	23 dBi (dual POL)	15 dBi (dual POL)	27 dBi (dual POL)
Beamwidth horizontal	90 deg.	-	10 deg.	30 deg.	30 deg.	60 or 15 deg.	7 deg.	30 deg.	6 deg.
Beamwidth vertical	20 deg.	-	10 deg.	30 deg.	30 deg.	15 or 60 deg.	9 deg.	30 deg.	6 deg.
Mounting									
Pole diameter	2.5 – 5 cm 1 – 2 in	3.5 – 6 cm 1.3 – 2.3 in	2 – 5 cm 1 – 2 in	3.5 – 6 cm 1.3 – 2.3 in	2 – 7 cm 0.8 – 2.7 in	3 – 7 cm 1.2 – 2.7 in	3 – 7 cm 1.2 – 2.7 in	5 – 7 cm 2 – 2.7 in	3 – 6 cm 1.2 – 2.3 in
Tilting	+10 /- 30 degrees	-	+/- 40 degrees	-	-	-	+45 /- 60 degrees	+/- 40 degrees	+30 /- 22 degrees
Powering									
Method	Passive PoE; 4,5 pin (+) and 7,8 pin (-)								
Input voltage	12 – 24 V								
Power consumption	4.5 W								

* Country dependent

Product comparison

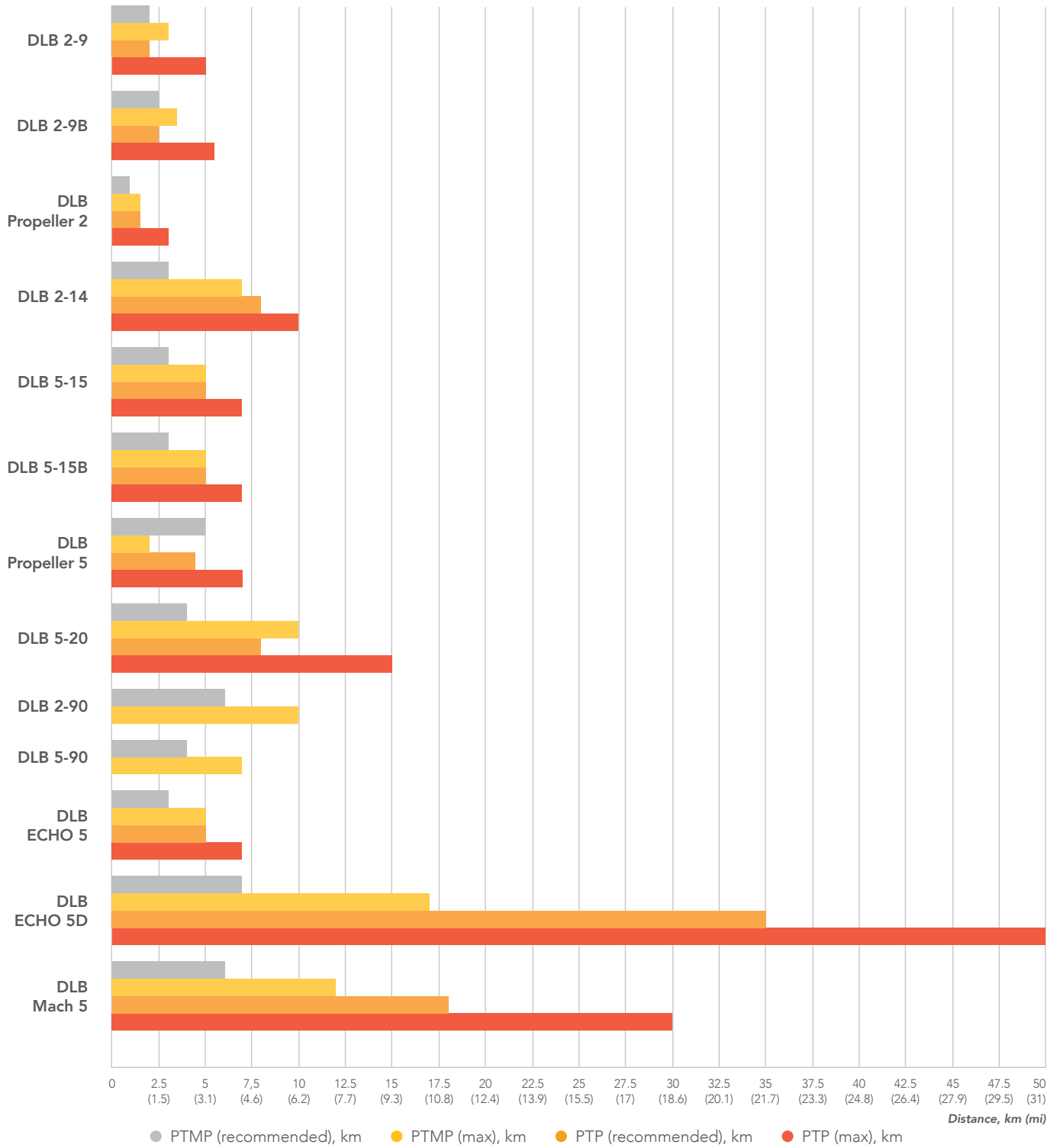



LigoPTP series

LigoWave's point to point equipment is known for great performance, reliability and cost effectiveness. The 5 GHz unlicensed band products are universal and suitable for a variety of vertical markets including Internet service providers, operators, enterprises, governmental organizations, industry, and security companies. State of the art RF design, powerful & dedicated CPU platforms, and an easy to use and configure operating system make the LigoPTP series equipment ideal for most PTP applications. Rugged and weather-proof enclosures, professional mounting brackets and integrated IEC standards rated surge protection ensures the reliability required for all carrier-grade wireless equipment.

LigoPTP RapidFire

is a new 5 GHz point-to-point system with an exceptional performance, delivering 700 Mbps maximum capacity. Carrier-grade design, simple and user-friendly interface makes RapidFire an ideal device for a capacity and performance demanding backhaul solutions.



Outstanding capacity

RapidFire delivers an extremely high 700 Mbps throughput via its unique and powerful RF design that supports up to 256QAM modulation and 31 dBi output power. Our proprietary W-Jet V protocol, specifically engineered for high performing PTP scenarios, minimizes interferences even across long distances and stabilizes latency within 2-4 ms.



Powerful all-in-one hardware platform

LigoWave RapidFire delivers powerful performance with its new 1.2 GHz CPU dedicated for data processing and high (200,000) packets per second rate. Equipped with two Gigabit Ethernet ports, one with PoE passthrough, the unit is ideal for repeater links and fits well in high-security video surveillance scenarios.

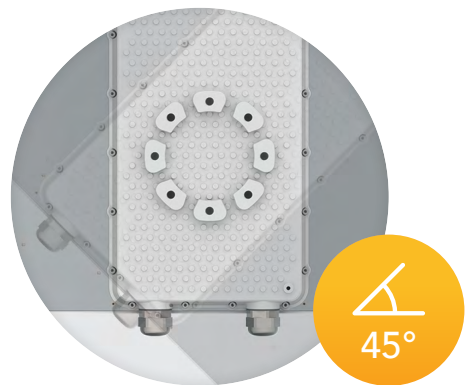

Professional design

In addition to achieving maximum performance, LigoWave focuses on delivering flexibility and ease-of-use. The robust mounting bracket ensures survivability during high wind-load. The integrated antenna possesses a 45° rotation option which increases installation flexibility; especially advantageous in noisy spectrum areas.

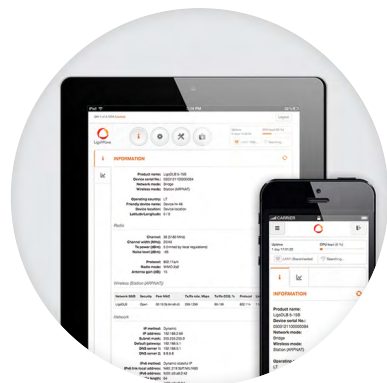

Wireless configuration interface

An internal 2.4 GHz radio allows access into the RapidFire GUI by wireless connection with any WIFI equipped device. The flexible OS provides a setup wizard and a single-side configuration feature, making link setup easy and straight forward. Essential tools like spectrum analyzer, site survey and others are included.

Product summary



Product	LigoPTP PRO		LigoPTP UNITY		LigoPTP 5-23 RapidFire	LigoPTP 620HP
Role description	Professional unlicensed band wireless PTP link for long range backhaul applications		Professional unlicensed band wireless PTP link for long range and high performance backhaul applications		Ultra high capacity (700 Mbps) new generation PTP equipment for the unlicensed band	Professional licensed band microwave PTP link for long range and high capacity backhaul applications
Radio						
Frequency	4.780 – 6.300 GHz*			4.9 - 6.1*		6, 7, 8, 10, 11, 13, 15, 18, 23, 26, 28, 32, 38 GHz
Channel size	20, 40 MHz			5, 10, 20, 40, 80		7, 14, 27.5, 28, 40, 56 MHz (ETSI/CEPT); 10, 20, 25, 30, 40, 50, 60 MHz (ANSI/FCC)
Duplexing	TDD			TDD		FDD
Stream	MIMO 2x2			MiMo 2x2		SISO 1x1
Wireless protocol	Proprietary W-Jet 2		Proprietary W-Jet 3		Proprietary W-Jet 5	Microwave radio relay
Protection	None		1+1, 2+0		1+1***	1+1, 2+0
Max output power	30 dBm**			31 dBm**		30 dBm
Modulation schemes	BPSK, QPSK, 16QAM, 64QAM			BPSK, QPSK, 16-QAM, 64-QAM, 256-QAM		QPSK, 8PSK, 16QAM, 32QAM, 64QAM, 128QAM, 256QAM
Network						
Ethernet interface	10/100/1000 Base-T		2x 10/100/1000 Base-T		2x 10/100/1000 Base-T	3x 10/100/1000 Base-T; 2x gigabit SFP
Aggregated data throughput	220 Mbps			700 Mbps		730 Mbps
Antenna						
Type	Integrated dual pol directional panel; N-type connectors for external antenna					1, 2, 3, 4, 6 ft dishes
Gain	23 dBi					27 – 49 dBi
Mounting						
Pole diameter	3 - 7 cm 1.2 – 2.7 in			1 - 12.4 cm 0.39 - 4.88 in		5 - 11 cm 2 – 4.3 in
Tilting	+45 / -60 degrees			+25 / -45 degrees		+/- 30 degrees
Powering						
Method	PoE 802.3af			802.3af/at		DC terminal block
Input voltage	+/- 48 VDC		+48 VDC		+/- 42 - 57 VDC	-20 to -60 VDC
Power consumption	8 W		12 W		8.6 W	45 W (IDU + ODU)

*Power is lower at frequency edges

** Country dependent

***Available in future software release

Product comparison

LigoPTP PRO, UNITY and RapidFire

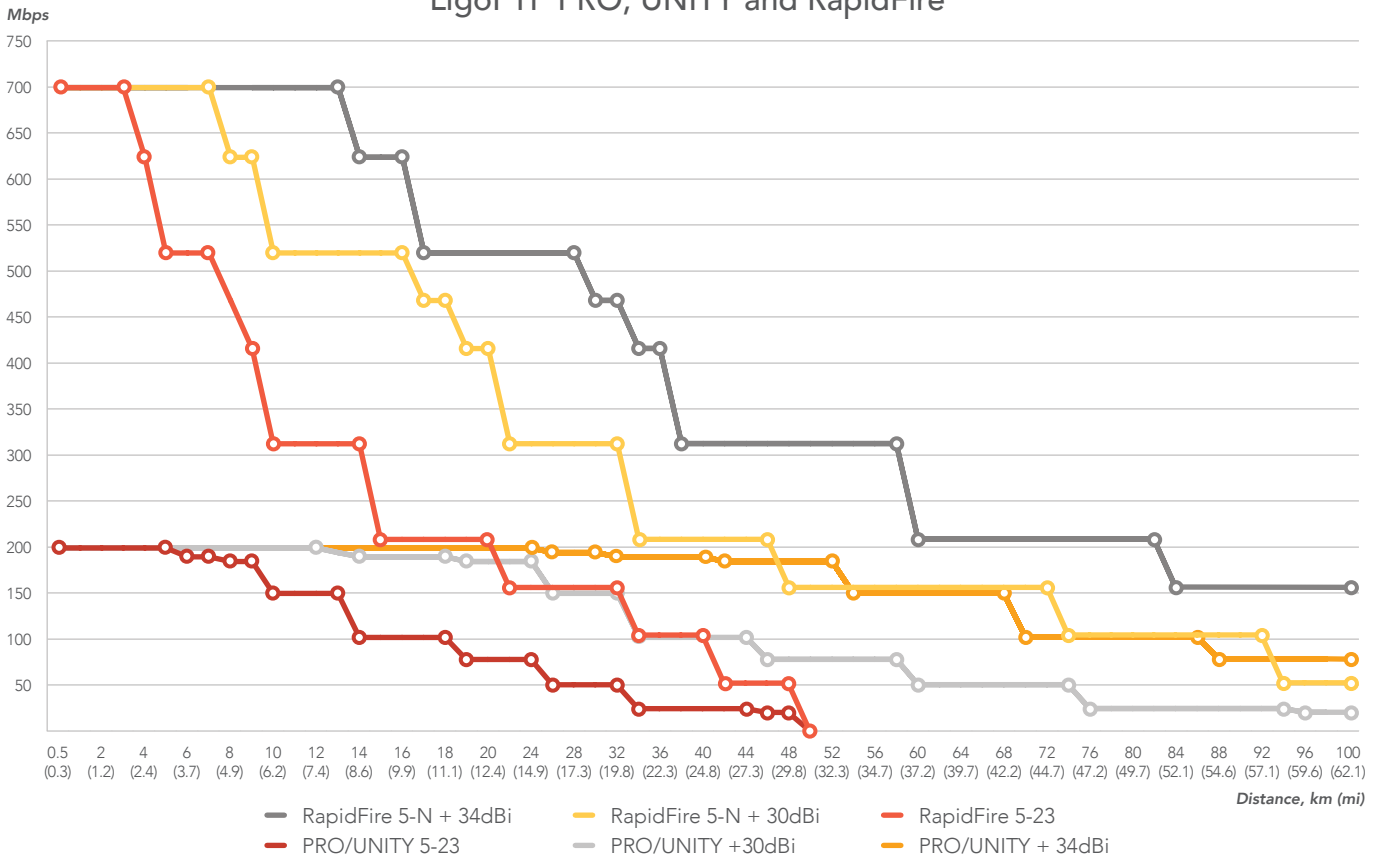

Packets per second rate, (thousands)

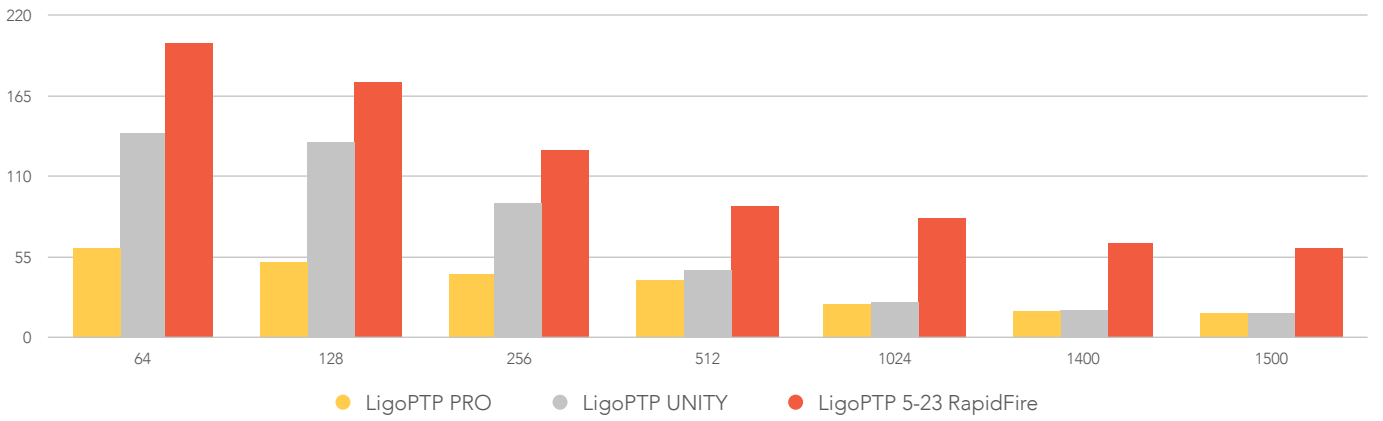

Throughput, Mbps

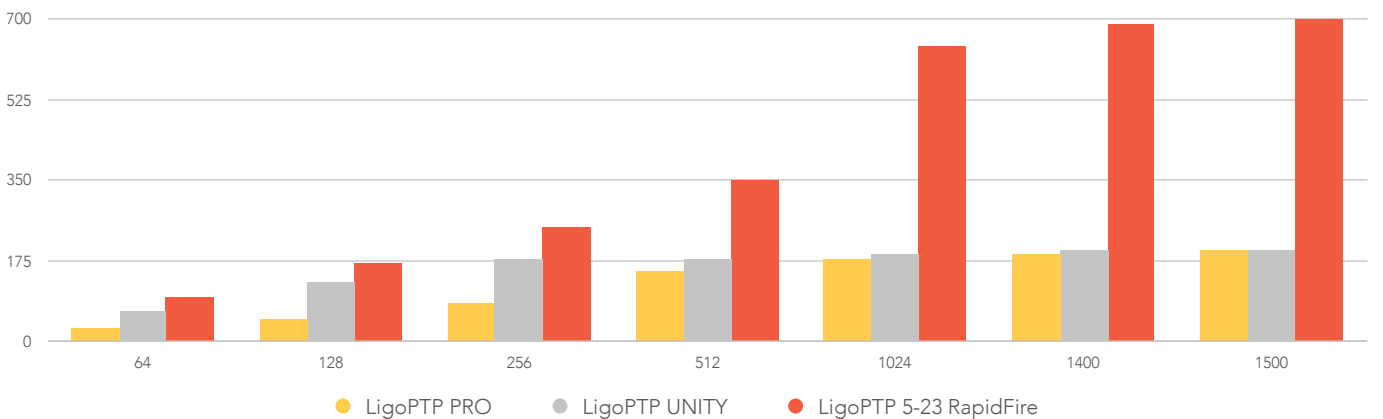



Infinity series

LigoWave's Infinity series equipment is made for the indoor-enterprise wireless market segment. A variety of access point models, with different hardware characteristics, were designed for a multitude of deployment scenarios. Some models include multiple radios, additional Ethernet ports, wall / ceiling mount, and metal enclosures. All models include a powerful and easy-to-use operating system, captive portal management, 8 or more SSID's and remote management via LigoWave's free Wireless Network Management System (WNMS).

Product summary



Product	NFT 2N	NFT 1Ni
Role description	High performance dual-radio dual-band 3x3 MIMO indoor AP for medium to large size enterprise applications	High power 2.4 GHz indoor AP with two Ethernet ports and PoE pass-through for small to medium enterprise applications
Radio		
Frequency	2.402 – 2.484 GHz; 5.170 – 5.875 GHz	2.402 – 2.484 GHz
Channel size	20, 40 MHz	
Stream	Dual MIMO 3x3	MIMO 2x2
Wireless protocol	802.11a/b/g/n	802.11b/g/n
Max output power	25 dBm (2.4G)*; 24 dBm (5G)*	31 dBm*
Receive sensitivity at 20 MHz channel	-90 dBm +/-2 dB @BPSK -84 dBm +/-2 dB @QPSK -80 dBm +/-2 dB @16QAM -72 dBm +/- 2 dB @64QAM	-93 dBm +/-2 dB @BPSK -87 dBm +/-2 dB @QPSK -82 dBm +/-2 dB @16QAM -76 dBm +/- 2 dB @64QAM
Tilting	+45 / -60 degrees	+/- 30 degrees
Powering		
Method	PoE 802.3af/at; Passive PoE	Passive PoE; 4,5 pin (+) and 7,8 pin (-)
Input voltage	48 V	12 – 24 V
Power consumption	8 W	4.5 W

*Power is lower at frequency edges

** Country dependent

Accessories

A range of professionally designed accessories including power adapters, converters, and professional outdoor cable are available to make the installation of the LigoWave devices efficient and trouble-free.



Product	LigoPoE AC to 24V adapter	LigoPoE AC to 48V af/at adapter	LigoPoE 12-24 DC to 48V af/at converter	LigoPoE 802.3af to 24V converter
Role description	Used to power all passive PoE devices from AC power source	Used to power standard 802.3af/at devices from AC power source	Used to power standard 802.3af/at devices from 12-24 VDC power sources (solar, wind power)	Used to power passive PoE devices from 802.3af/at power sources (PoE switches)
Used with products	APC, LigoDLB series	LigoPTP PRO, LigoPTP UNITY, LigoPTP RapidFire, NFT 2N, NFT 3AC	LigoPTP PRO, LigoPTP UNITY, LigoPTP RapidFire, NFT 2N, NFT 3AC	APC, LigoDLB series
Electrical specifications				
Data speed	100 Mbps	1000 Mbps	1000 Mbps	100 Mbps
Input voltage	100 – 240 VAC, 50/60 Hz		12 – 24 VDC	37 – 57 VDC
Output voltage	24 VDC	48 VDC	48 VDC	24 VDC
Power	12 W	24 W	30 W	13 W



Outdoor cable

LigoWave's outdoor cable is a professional Cat 5e FTP outdoor cable designed for maximum performance (1 Gbps full-duplex) and reliability. Outdoor cable is made from high quality twisted copper conductors, includes a drain wire for ESD grounding and is enclosed by a foil shield and a weatherproof jacket.

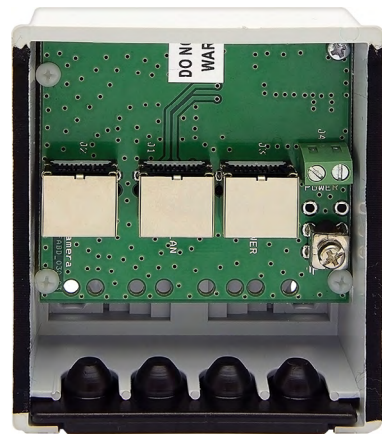

PoE splitter

The PoE Splitter is a passive outdoor product, which interconnects two PoE-PD devices for data transferring and powering purposes. The PoE Splitter is ideal for video surveillance and repeater applications. It has integrated ESD and surge protection, which increases service reliability.

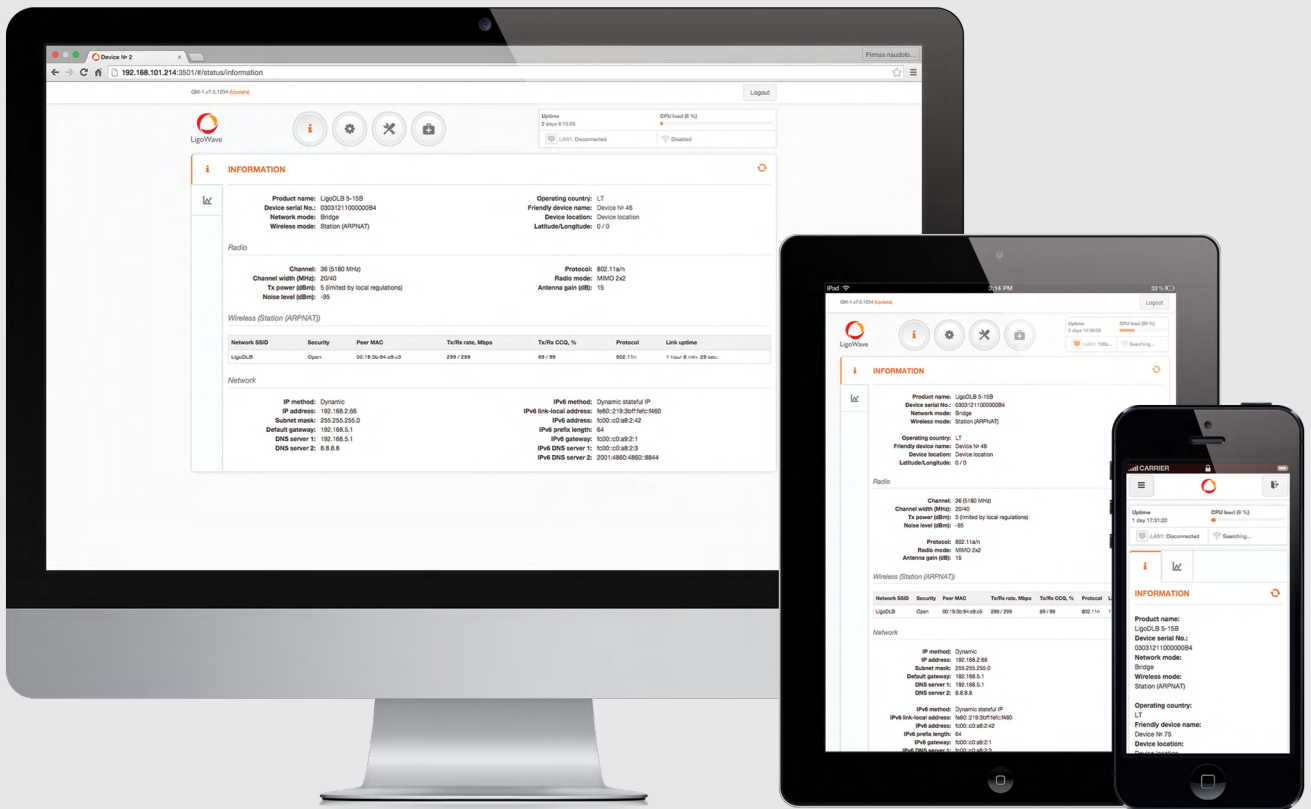

LigoWave software

LigoWave's proprietary operating system is a powerful, flexible and efficient software architecture that is embedded in all the devices it manufactures. Every product line has its own dedicated library of features and algorithms which are selected according to the specific requirements of each model. Tightly coupling the unique software with a variety of hardware options differentiates LigoWave from the competition. Implementation of the latest technologies, including HTML 5, is used to create an attractive and user-friendly, graphical user interface and powerful tools for simple installation and ease of management. This professional and innovative software makes LigoWave's wireless equipment a leader in the wireless broadband market.



WNMS

Wireless Network Management System

WNMS is a FREE enterprise grade Wireless Network Management System. A single software solution simplifies a large number of management and monitoring tasks for network administrators. LigoWave's comprehensive network management system supports several thousands of nodes. Multiple networks may be maintained and monitored using one server. A rich feature set helps to diagnose network problems effectively, visualize networks on a map, perform scheduled firmware upgrades automatically, track states of devices, get failure alerts, and collect statistics. The Web-based system environment supports multi-user accounts. Several administrators can manage different networks on the same server, without having access to each other's equipment.

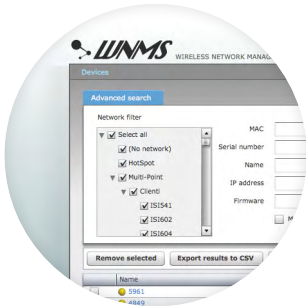

Flexible monitoring

Monitor your network and device status. Define monitoring profiles from desirable tracking parameters.



Get reports about your network

Define profiles for collection of SNMP based statistical data from devices and create graphical reports.

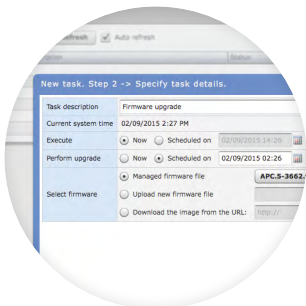

Main task execution

Push configuration files to a device, get configurations file from a device, upgrade a firmware, get a troubleshooting file or reboot. You can run tasks immediately or schedule them according to your needs.



Visualize network on maps

See your network and devices on maps including availability status. Inspect topology maps and create interconnections between devices according to your network structure.



WNMS Cloud

Cloud based Wireless Network



WNMS Cloud is a new carefree way to manage your LigoWave powered wireless networks – now you can get your own dedicated WNMS server up and running in a matter of minutes!

And best of all, a trial account (limited to a maximum of 20 managed devices) is totally FREE with no registration or subscription fees.

You can try it by visiting www.wnmscloud.com



WNMS Mobile

Monitor your network using mobile device

WNMS Mobile is an Android based client application for devices monitored by a WNMS (Wireless Network Management System) server. WNMS Mobile is designed for network operating center coordinators, maintenance staff, and support engineers.

WNMS mobile does the following:

- Lists the availability of networks and devices
- Marks each device location on a map
- Registers the devices into WNMS. The application can use the coordinates from the Android device
- Lists all devices alerts
- Allows ToDo list for each user
- Notifies the responsible person through push notification service when a task is assigned, reassigned, completed or rejected
- Provides flexible data filtering capabilities

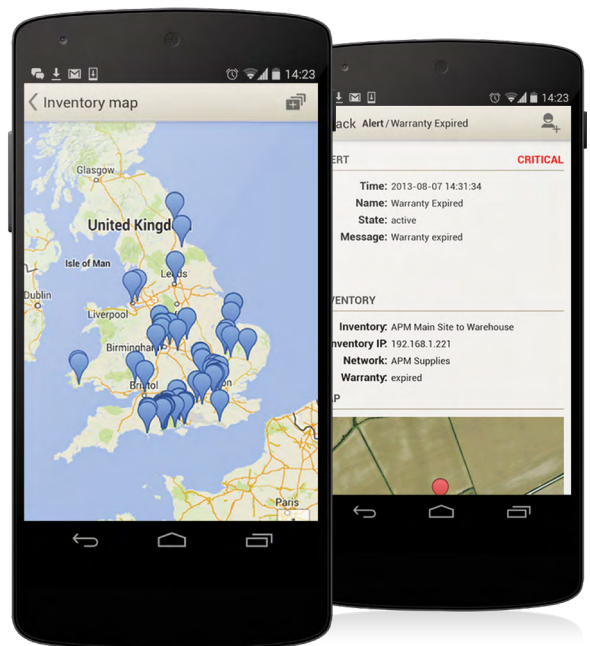

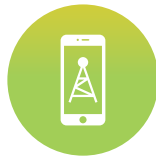

Installer APP

Monitor your network using mobile device

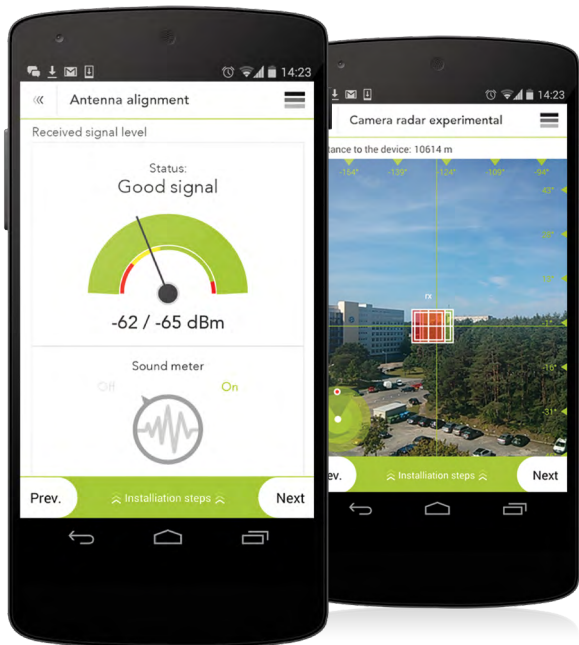

LigoWave's Wireless Installer App is a handy application designed to simplify and speed up the wireless link installation process for the engineers working in the field. It was developed for Android based handheld devices and is intended to be used with LigoWave products, however a majority of the available features can be used with 3rd party equipment.

The Wireless Installer App provides the following aids:

- Finding the direction of a remote site / device on a map
- Showing of the exact location of a remote device using an integrated camera in the phone or tablet
- Reporting wireless link signal levels as audible signals coming from the handheld device (in a noisy areas a Bluetooth handset is recommended)
- Measuring link performance throughput and PPS using different packet sizes
- Configuring basic parameters required for link establishment
- Multiple options to import the coordinates: WNMS, LinkCalc, Google Earth (kmz file) and manually.



LinkCalc

Link path analysis calculator

LigoWave's LinkCalc is a link planning tool available online. The link calculator allows equipment users to calculate link performance expectations taking into account geographical information, distance between the units, antenna height and gain, transmit power, and other factors in order to choose the most suitable product available from LigoWave's extensive product portfolio. In addition, custom calculations using other vendors' equipment specs can be used, making the LigoWave link calculator the ultimate link planning tool. This tool is offered free of charge, and users only need to register to get quick and easy access. Each user is able to create a database of links, download link calculations as PDF documents, and publish a hyperlink online so that it could be shared during the evaluation process.

You can try it by visiting <https://linkcalc.ligowave.com>

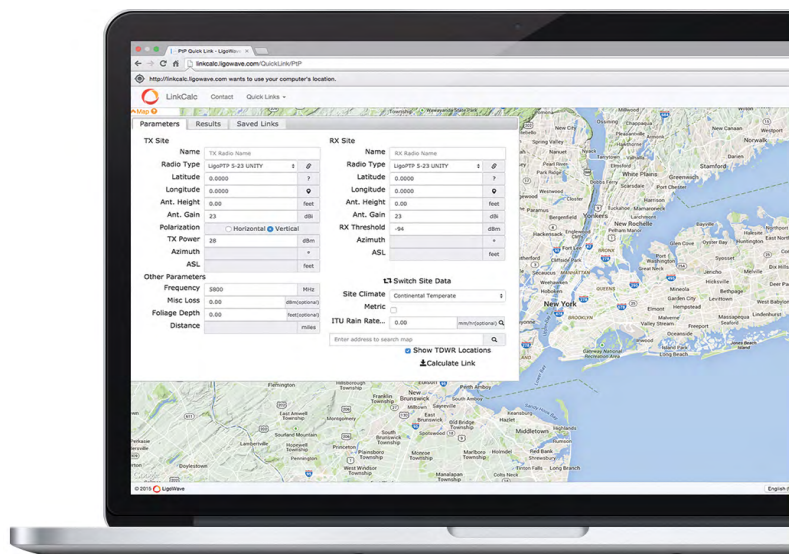



LigoWave

Copyright © 2015 LigoWave LLC. All rights reserved. LigoWave, the LigoWave logo, are trademarks of LigoWave LLC. All other company and product names may be trademarks of their respective companies. While every effort is made to ensure the information given is accurate, LigoWave does not accept liability for any errors or mistakes which may arise. Specifications and other information in this document may be subject to change without notice.

To learn more about LigoWave products, visit www.ligowave.com.