



LigoPTP MiMo

User's Guide

Revision 1.3
May 18, 2010

Copyright

© 2005-2010 LigoWave

This user's guide and the software described in it are copyrighted with all rights reserved. No part of this publication may be reproduced, transmitted, transcribed, stored in a retrieval system, or translated into any language in any form by any means without the written permission of LigoWave.

Notice

LigoWave reserves the right to change specifications without prior notice.

While the information in this manual has been compiled with great care, it may not be deemed an assurance of product characteristics. LigoWave shall be liable only to the degree specified in the terms of sale and delivery.

The reproduction and distribution of the documentation and software supplied with this product and the use of its contents is subject to written authorization from LigoWave.

Trademarks

LigoWave logo is trademark of LigoWave LLC.

All other registered and unregistered trademarks in this document are the sole property of their respective owners.

FCC Warning

This equipment has been tested and found to comply with the limits for a Class B digital device, pursuant to Part 15 of the FCC Rules. These limits are designed to provide reasonable protection against harmful interference in a residential installation. This equipment generates, uses, and can radiate radio frequency energy and, if not installed and used in accordance with the instructions, may cause harmful interference to radio communications. However, there is no guarantee that interference will not occur in a particular installation. If this equipment does cause harmful interference to radio or television reception, which can be determined by turning the equipment off and on, the user is encouraged to try to correct the interference by one of the following measures:

- Reorient or relocate the receiving antenna.
- Increase the separation between the equipment and receiver.
- Connect the equipment into an outlet on a circuit different from that to which the receiver is connected.
- Consult the dealer or an experienced radio/TV technician for help.

This device complies with Part 15 of the FCC Rules. Operation is subject to the following two conditions: (1) This device may not cause harmful interference, and (2) this device must accept any interference received, including interference that may cause undesired operation.

FCC Caution

To assure continued compliance, any changes or modifications not expressly approved by the party responsible for compliance could void the user's authority to operate this equipment.

FCC Radiation Exposure Statement

To comply with FCC RF exposure requirements in section 1.1307, a minimum separation distance of 3.9 feet is required between the antenna and all occupational persons, and a minimum separation distance of 8.7 feet is required between the antenna and all public persons.

CE Mark Warning

This is a Class A product. In a domestic environment this product may cause radio interference in which case the user may be required to take adequate measures.

R&TTE Compliance Statement

This equipment complies with all the requirements of the Directive 1999/5/EC of the European Parliament and the Council of 9 March 1999 on Radio Equipment and Telecommunication Terminal Equipment and the Mutual Recognition of their Conformity (R&TTE). The R&TTE Directive repeals and replaces in the directive 98/13/EEC (Telecommunications Terminal Equipment and Satellite Earth Station Equipment) As of April 8, 2000.

Safety

This equipment is designed with the utmost care for the safety of those who install and use it. However, special attention must be paid to the dangers of electric shock and static electricity when working with electrical equipment. All guidelines of this manual and of the computer manufacturer must therefore be allowed at all times to ensure the safe use of the equipment.

EU Countries Intended for Use

The ETSI version of this device is intended for home and office use in Austria, Belgium, Denmark, Finland, France (with Frequency channel restrictions), Germany, Greece, Ireland, Italy, Luxembourg, The Netherlands, Portugal, Spain, Sweden and United Kingdom. The ETSI version of this device is also authorized for use in EFTA member states Iceland, Liechtenstein, Norway and Switzerland.

EU Countries Not Intended for Use

None.

Contents

Copyright	2
Notice	2
Trademarks	2
FCC Warning.....	3
FCC Caution	3
FCC Radiation Exposure Statement	3
CE Mark Warning	3
R&TTE Compliance Statement	3
Safety.....	3
EU Countries Intended for Use	3
EU Countries Not Intended for Use.....	3
CONTENTS.....	4
ABOUT THIS GUIDE.....	6
Purpose	6
Definitions, Acronyms and Abbreviations.....	6
INTRODUCTION.....	7
Application Examples	8
Building to Building Connectivity.....	8
Backhaul	8
PTP Features	9
Technical Features.....	9
Management	9
Reliability.....	9
PTP INSTALLATION	10
Package Contents	10
Hardware Introduction	11
Connectors.....	12
Accessing the PTP Unit's Web Management	12
Default Settings.....	13
Quick Setup Guide	13
Verify PTP Link Connection	18
PTP LINK ESTABLISHMENT	21
Mounting the PTP Unit	21
Mounting on a Pipe	22
Mounting on a Wall	22
Align Antenna	23
WEB MANAGEMENT.....	24
General Operation	24
Instant Changes.....	24
System Warnings and Errors	24
Signal Indicator	25
Status	27
System	27
Network	28
Wireless	28
Statistics.....	29
Graphs	30

Configuration	33
Network	33
Radio	34
Instant Changes	34
System	36
Link Settings	36
System Date	36
Administrative Account	37
System Log	38
Services	39
SNMP Configuration	39
WNMS Configuration	40
System Alerts	40
Maintenance	41
System Functions	42
OLED Control	43
Firmware Upgrade	44
Tools	44
Antenna Alignment	45
Site Survey	45
Link Test	46
Logout	48
OLED CONTROL	49
OLED States	49
OLED Usage	49
OLED Menu Structure	49
OLED Functionality	50
Unlock the OLED	51
Run Antenna Alignment	51
Run Link Test	51
Statistics	52
Reboot	54
Reset to Defaults	54
Lock the OLED	55
APPENDIX	56
A) Run PTP Link in Small Distance	56
B) Resetting Unit to Factory Defaults	59
INDEX	60

About This Guide

Purpose

This document provides information and procedures on installation, setup, configuration, and management of the PTP unit.

Definitions, Acronyms and Abbreviations

The following typographic conventions and symbols are used throughout this document:



Additional information that may be helpful but which is not required.



Important information that should be observed.

bold Menu commands, buttons, input fields, links, and configuration keys are displayed in bold

italic References to sections inside the document are displayed in italic.

`code` File names, directory names, form names, system-generated output, and user typed entries are displayed in constant-width type

Introduction

The PTP link consists of two units, one on each end: Master and Slave. Master unit operates as an access point; therefore the Slave connects to the Master and operates as a client.

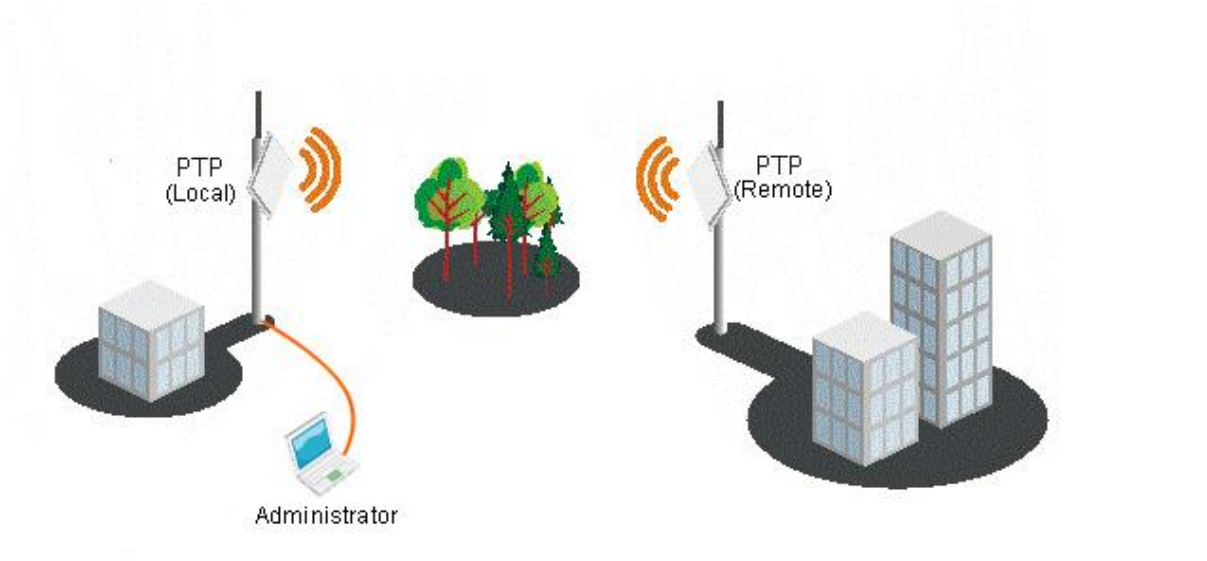

Figure 1 – Point-to-Point Link Elements

From the point of view of the administrator the **Local unit** is the one with the direct connection to the Web management interface and the **Remote unit** is the one which is connected to the Local unit in PTP link. The concept of the Local unit and the Remote unit is not related to the operating mode (Master or Slave). This terminology will be used throughout the manual, particularly in the description of statistics.

Application Examples

Building to Building Connectivity

Use the PTP for building to building connectivity in the private networks such as campus building connections, corporate building connections, universities and schools that wish to own and manage their own networks and eliminate the costly recurring charges from service providers. The same connectivity is perfect to build backup/failover connections.

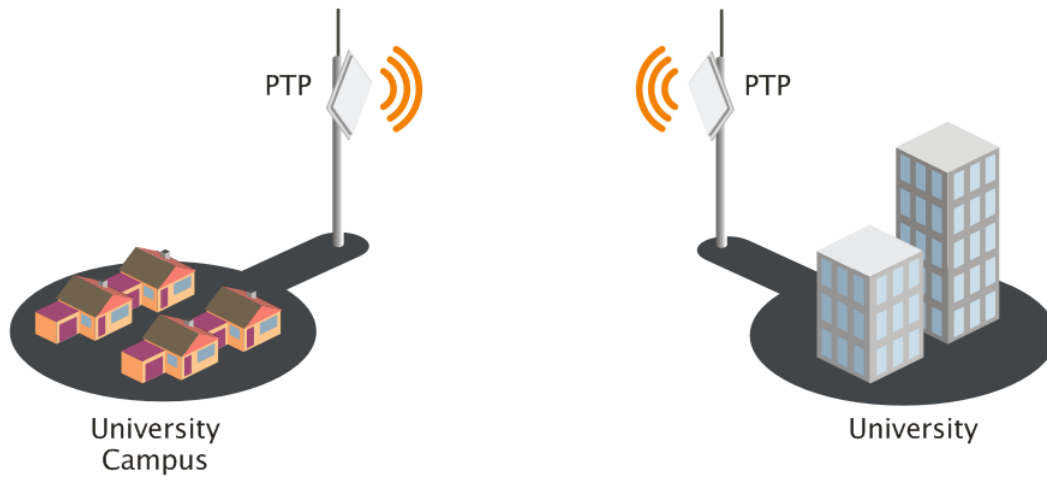

Figure 2 – Building to Building Connectivity

Backhaul

The PTP offers a cost effective solution made for WISPs, Cellular Carrier, Telco, ISPs, enabling operators to quickly and efficiently expand their networks.

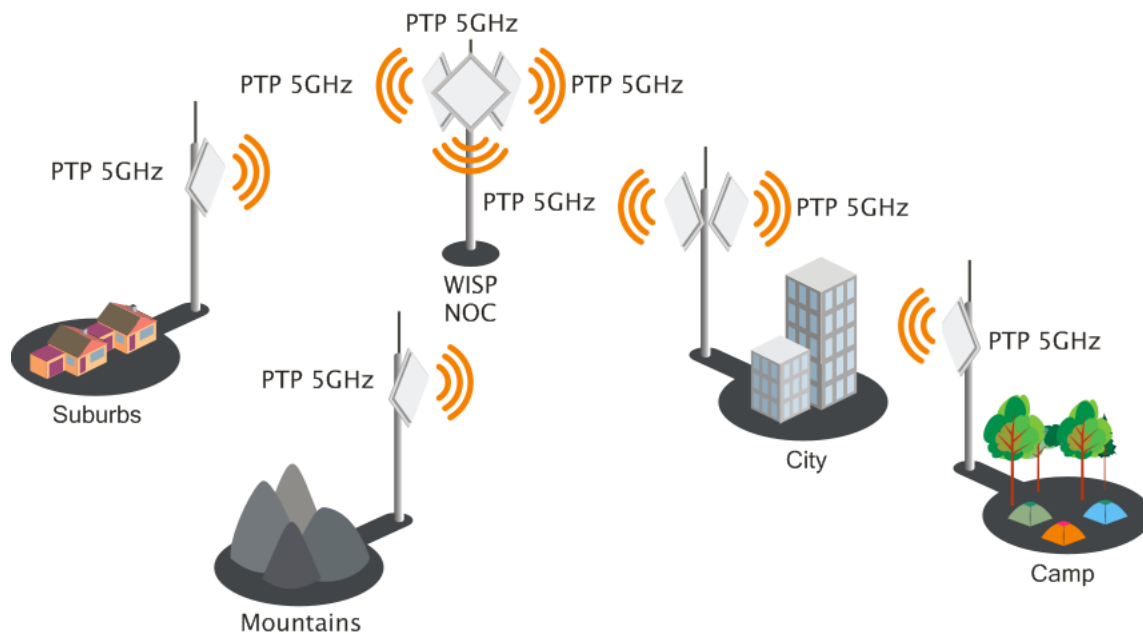

Figure 3 – PTP Backhaul

PTP Features

Technical Features

- High throughput;
- Flexible Channel Sizes (20MHz and 40MHz);
- Flexible center frequency selection (allows selecting center frequency in 5MHz step);
- Robust MAC layer:
 - Selective repeat ARQ with block ACK
 - Only lost packets are retransmitted
 - Highly efficient in noisy environments
 - Low throughput loss over long distance
 - Forward error correction (recovers packets with errors without retransmit)
 - Dynamic TDD (see the *Figure 4 – Point to Point Protocol W-jet MIMO*)
 - Allocates bandwidth in the direction needed in real-time
 - Highly reliable and efficient over long distances
 - Packet aggregation (smaller frames are collected into larger frames to increase efficiency and throughput)
- High PPS (Packet Per Seconds) performance
- High TX power and RX Sensitivity
- PoE built-in for single cable installation



Figure 4 – Point to Point Protocol W-jet MIMO

Management

- Flex based fast GUI
- Command line management via SSH
- WNMS server support for configuration
- SNMP V1/2/3 with traps supporting MIBs: 802.1, 802.1x, MIBII
- Syslog support
- Reset over Ethernet on boot

Reliability

- Lightning protection
- Solid metal construction
- IP67 rated
- Proven software platform
- Extensive production testing

PTP Installation

This chapter provides installation instructions for the hardware and software components of the PTP unit.

Package Contents

The PTP system is available in two versions:

- PTP unit with integrated antenna;
- PTP unit with N-type connector for external antenna.

Each PTP unit comes with the following:

Component Name	Quantity
Articulating Mounting Bracket Hardware	1
CAT5 Connector Cap	1
Integrated 48V(product dependent) PoE Power Supply & Injector	1
Custom Enclosure Hole Plug*	1

* For units with internal antenna only.



If any of these items are missing or damaged, please contact your reseller.

Hardware Introduction

The PTP unit is housed in an aluminum enclosure and features an N-Female type connector (if use external antennas) or an integrated antenna. The bottom panel of the PTP unit contains:

- **Data/Power connection** in the form of passive PoE through standard Ethernet cable
- **N-Female** type antenna connector (for units with external antenna only)
- **OLED screen** (for units with OLED)

The PTP units with integrated antenna has a custom enclosure hole plug instead of N-type connector.

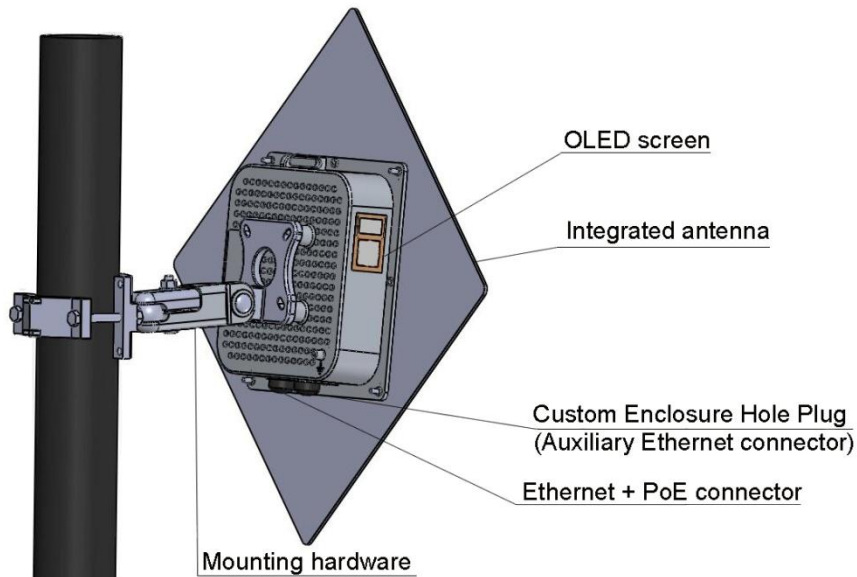

Figure 5 – General View of the PTP Unit with Integrated Antenna

The detailed back panel view of the PTP unit is displayed in the diagram below:

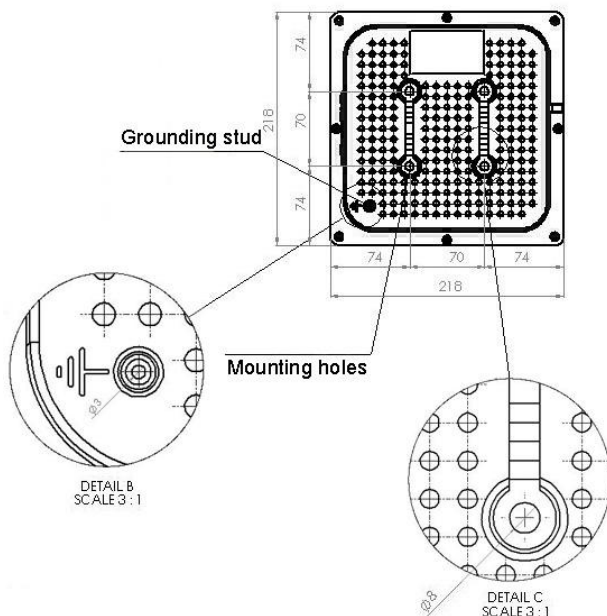

Figure 6 – PTP Unit's Back Panel Diagram

Connectors

The PTP unit has several connectors on the bottom and side panels.

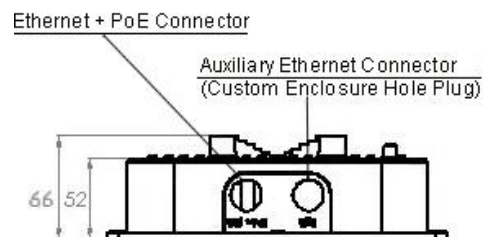

Figure 7 – Connectors

Descriptions of the connectors are given in the following table:

Connector	Description
PoE	Passive PoE with LAN port.
Antenna *	External antenna connector (type N-Female).

* For units with external antenna. If the unit comes with integrated antenna, there will be no N-type connector.

Accessing the PTP Unit's Web Management

The default IP address of the PTP unit is **192.168.2.66** with a subnet mask of 255.255.255.0.

- Step 1.** Configure your PC with a static IP address on the 192.168.2.0 subnet with mask 255.255.255.0.
- Step 2.** Connect the PTP unit in to the same physical network as your PC.
- Step 3.** Open the Web browser and browser, type the default IP address of the PTP unit <https://192.168.2.66/> to load the login page.
- Step 4.** Enter the default administrator login settings to access the Web management page. The default administrator login settings for PTP unit are:
Login: **admin**
Password: **admin01**
- Step 5.** After successful administrator log on you will see the main page of the PTP unit Web management interface. The PTP unit now is ready for configuration. For further instructions on configuration refer to the respective chapter *Web Management*.

Default Settings

The default settings of the PTP unit configuration parameters are listed in the table below:

Parameter	Default value
IP address	192.168.2.66
Netmask	255.255.255.0
Login	admin
Password	admin01
Link ID	Link name
Encryption	None
Ethernet configuration	auto
SNMP R/O community	public
SNMP R/O user	public
SNMP R/O password	password

Quick Setup Guide

- Step 1. Login in to the PTP unit web management.** To access the PTP unit Web management interface, configure your PC with a static IP address on the 192.168.2.0 subnet with mask 255.255.255.0. Connect the PTP unit in to the same physical network as your PC. Open the Web browser and type the default IP address of the PTP unit <https://192.168.2.66/> and the login page will be loaded. Enter default administrator login settings:



Figure 8 – Login Page



The default administrator login settings for PTP unit are:

Login: **admin**

Password: **admin01**

After successful administrator login you will see the main page of the PTP unit Web management interface. The PTP unit now is ready for configuration.

- Step 2. Specify the operation mode: Master or Slave.** The difference in configuration of Master and Slave is that the frequency does not need to be specified for the Slave. The Slave scans the air and chooses the frequency automatically after finding the Master.

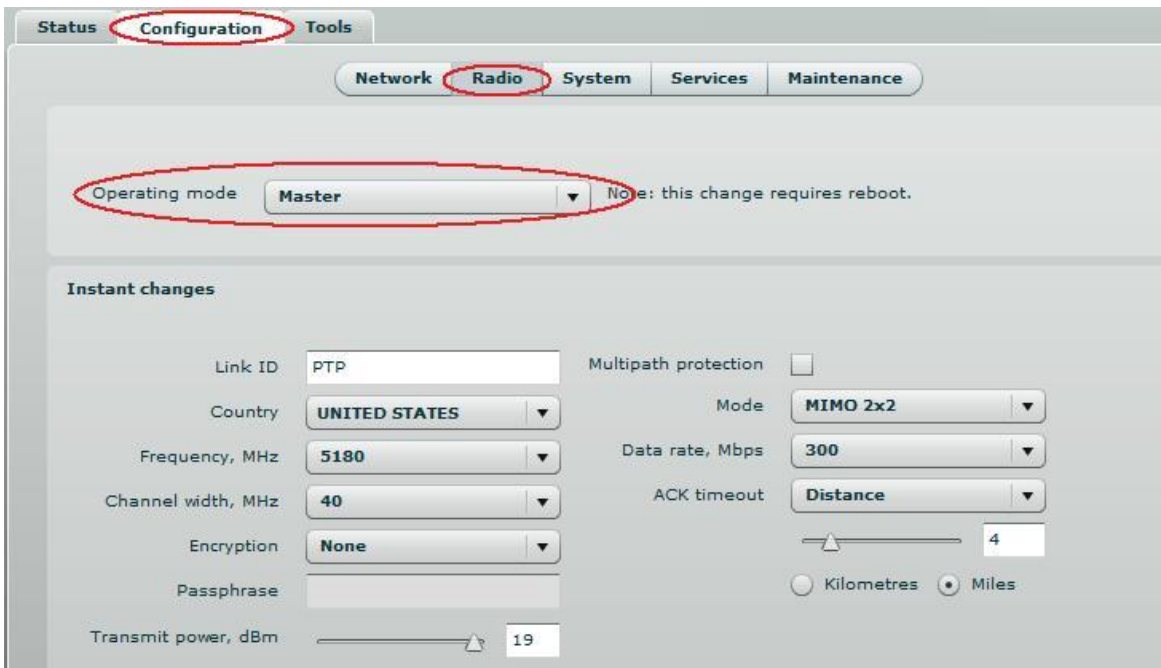

Figure 9 – Specify Unit's Operating Mode

Step 3. Specify a Link ID. Link ID must be identical for each unit of the same link. For instructions on changing this setting refer to the *Radio* section in the Web management chapter.

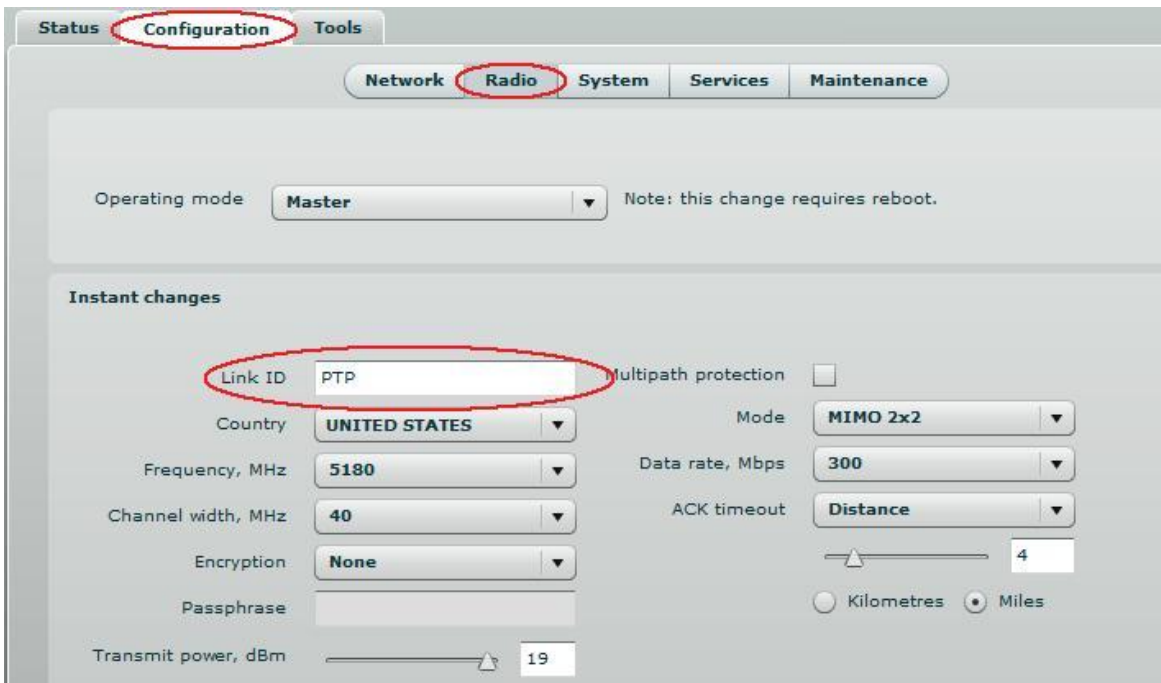

Figure 10 – Specify PTP Link ID

Step 4. Choose the Country in which the PTP link will operate. PTP unit will automatically adjust Radio settings to meet country/region specific regulations.

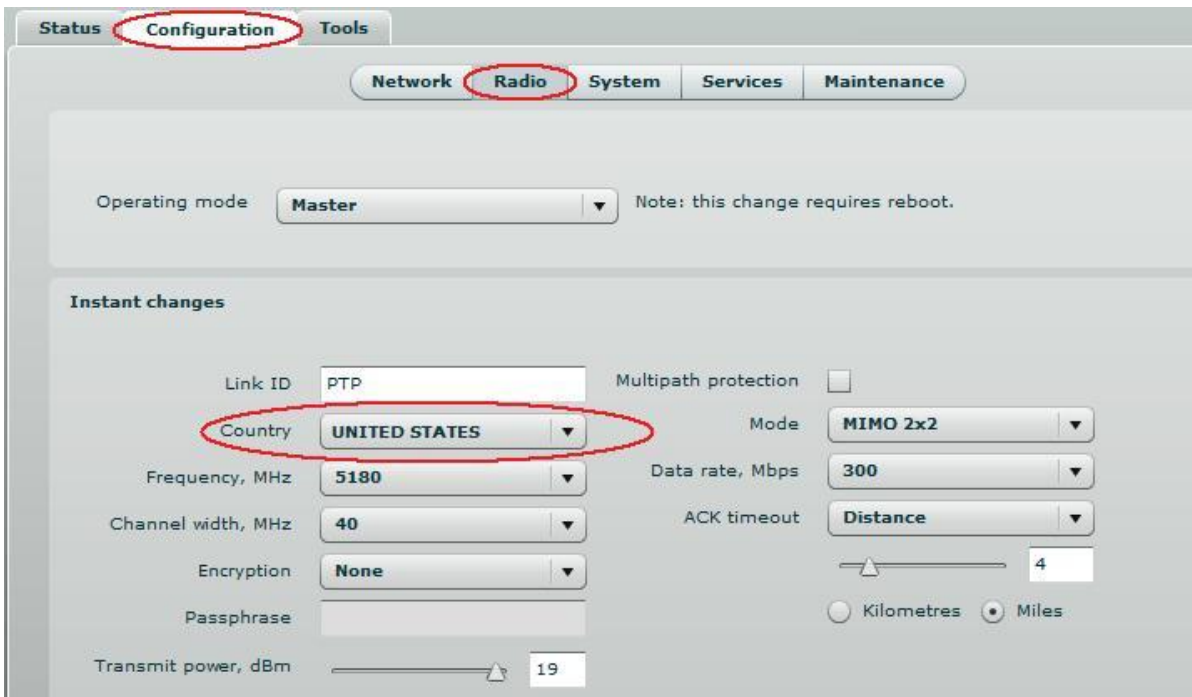

Figure 11 – Specify Country

Step 5. Set Frequency at which PTP link will operate on Master unit. Change Frequency applies only for Master units. The Slave unit will choose the frequency automatically after the Master unit will be found. For instructions on changing this setting refer to the *Radio* section in the Web management chapter.

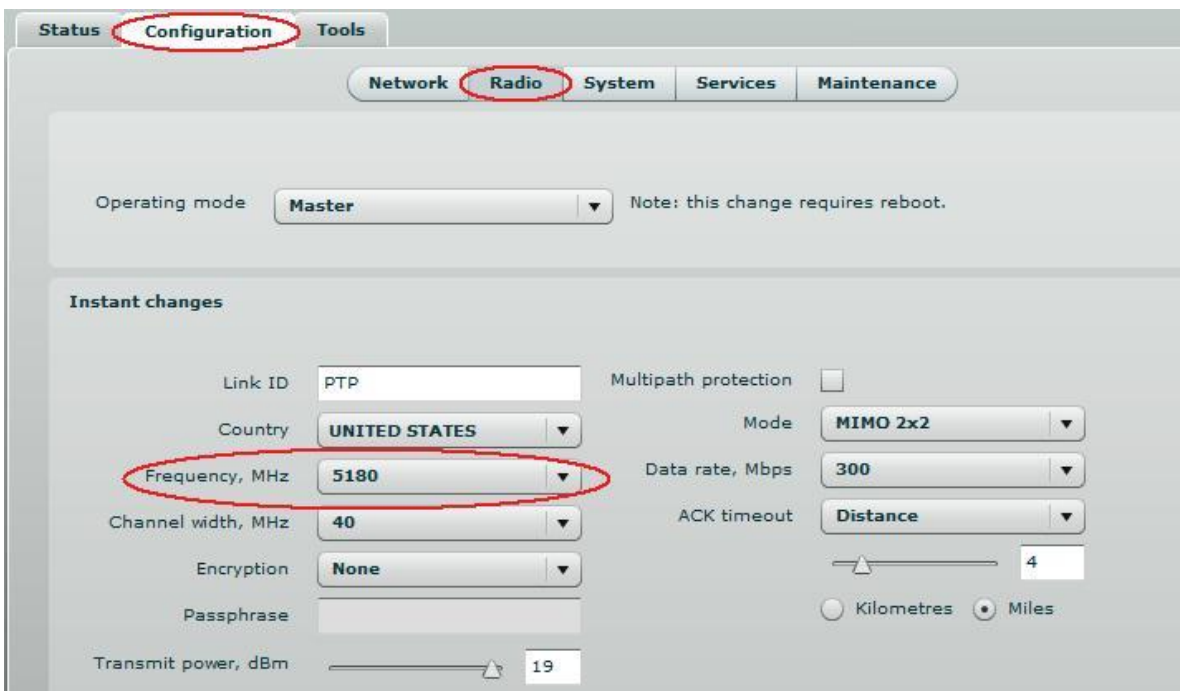

Figure 12 – Specify Frequency

Step 6. Set Channel width at which PTP link will operate. For instructions on changing this setting refer to the *Error! Reference source not found.* section in the Web management chapter.

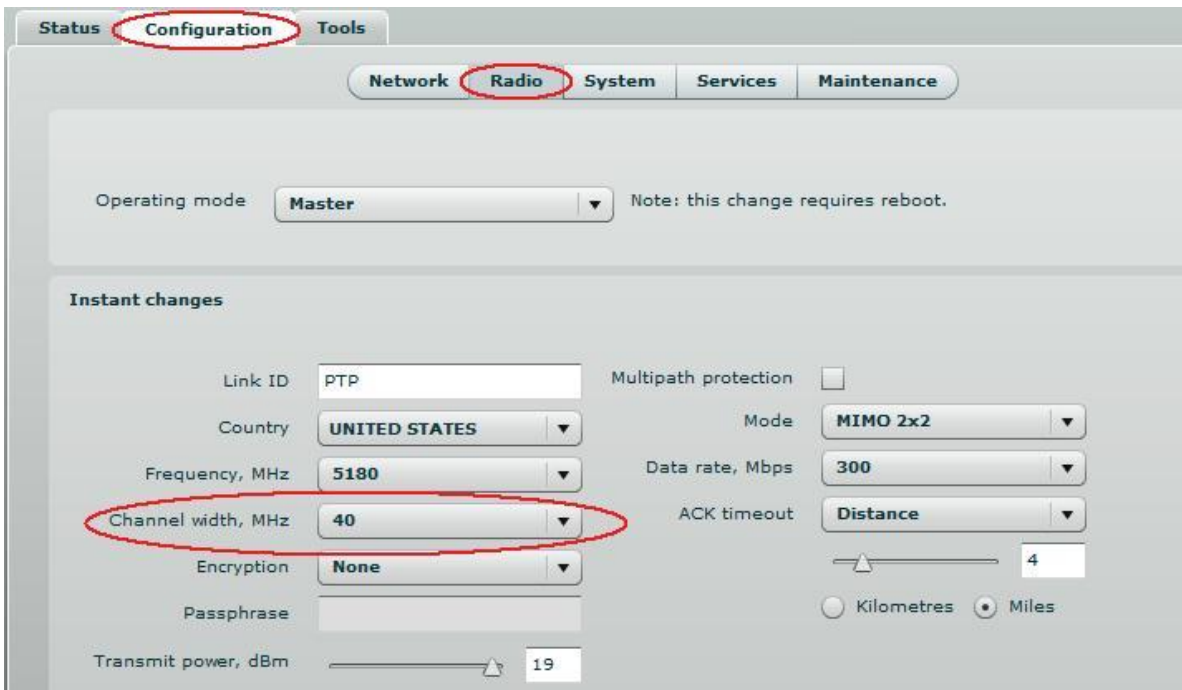

Figure 13 – Specify Channel Width

Step 7. Set link encryption for secure data transfer between PTP units. The security settings (encryption and passphrase) must be the same on each side of the link otherwise the link will not establish. For instructions on changing this setting refer to the *Radio* section in the Web management chapter.

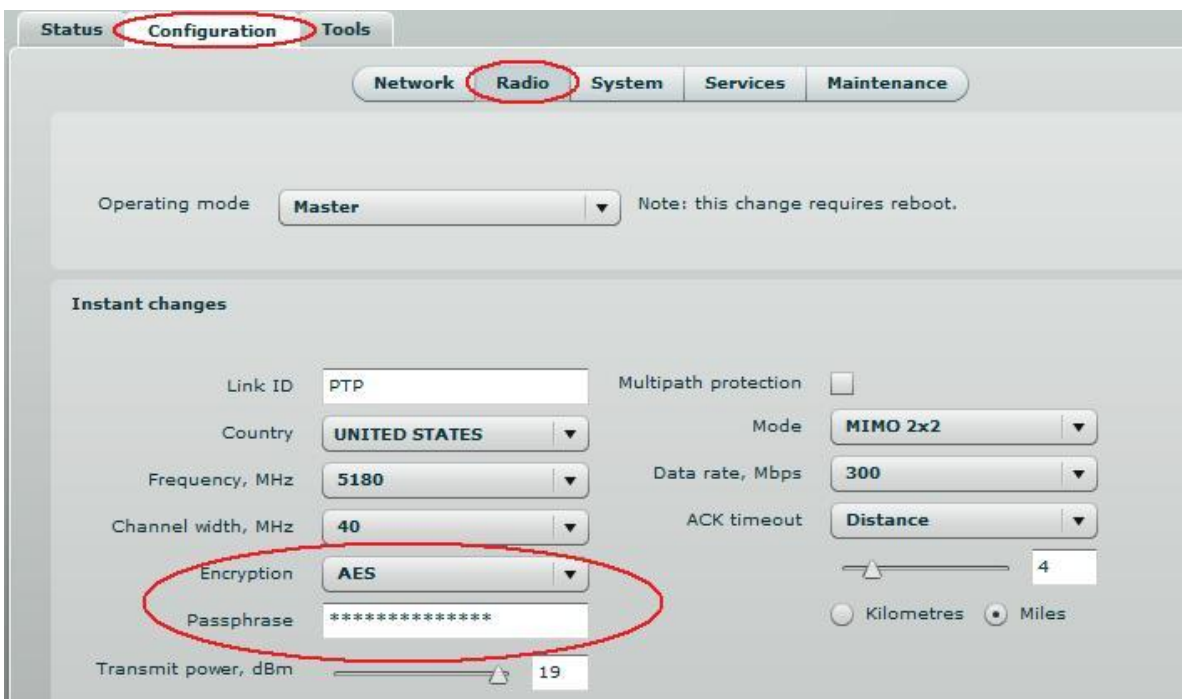

Figure 14 – Set the Encryption

Step 8. Reduce Transmit Power before testing the units placed on a table. PTP units placed in short distance with high transmit power may not work or even damage the peer's radio's receiver.

Step 9. Change web management login password. This is strongly recommended for security reasons. For instructions on changing the administrator's password refer to the corresponding section *Administrative Account*.

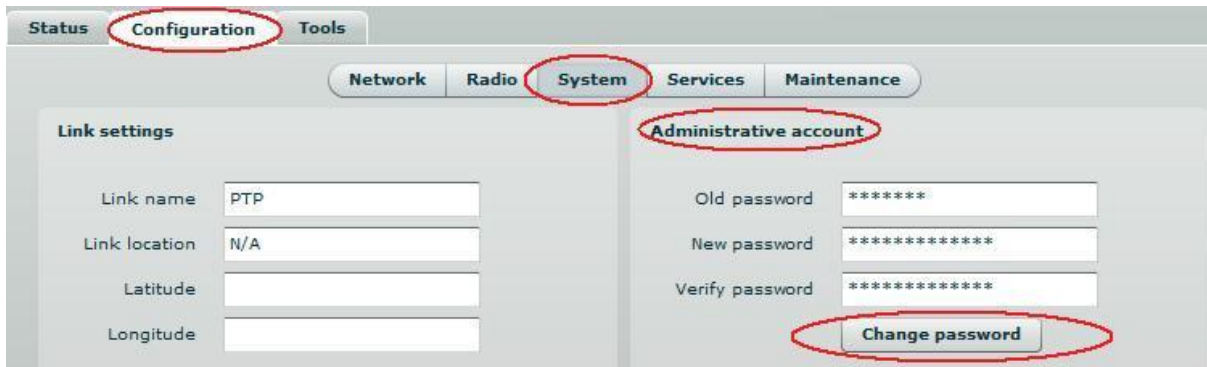

Figure 15 – Change Administrator's Password

Step 10. Save configuration and Reboot the device.

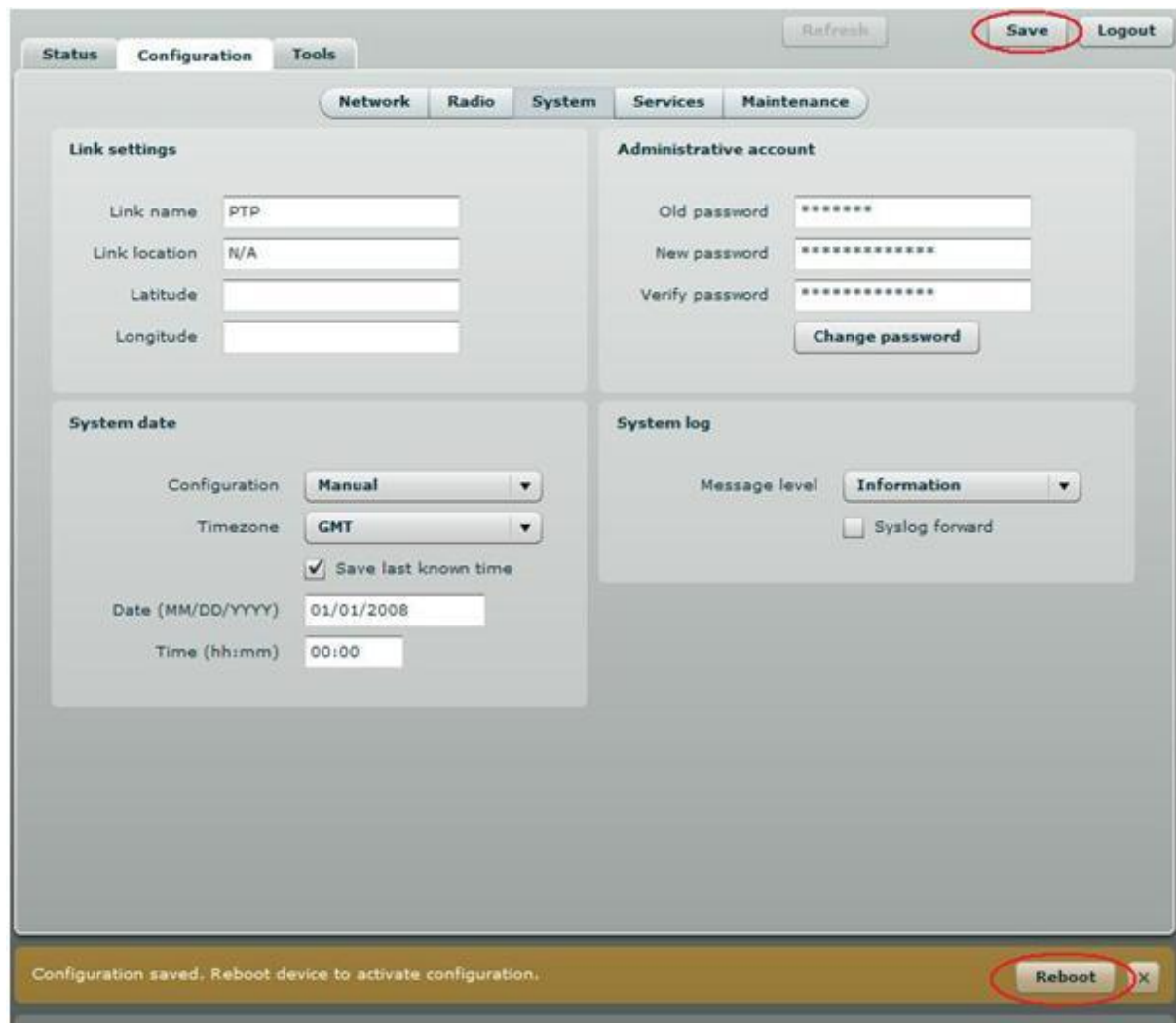

Figure 16 – Save Configuration

Step 11. Setup the second unit of the PTP link in the same way and check if configured units established a Link.

Verify PTP Link Connection

After the both units of the PTP Link are configured, verify the PTP link quality:

Step 1. Connect to the unit's web management interface.

Step 2. Check the **Signal Indicator** bar located at the bottom of the web management interface:



Figure 17 – Signal Indicator Bar

Step 3. Run the **iperf** tool (or use the *Link Test*) on server and client sides to verify the point-to-point connection:

```
File Edit View Terminal Help
mindaugas@mindaugas-desktop:~$ iperf -c 192.168.10.124 -w 85K -M 1.0K -l 2.0M -t 102 -i 2
WARNING: attempt to set TCP maximum segment size to 1024, but got 536
-----
Client connecting to 192.168.10.124, TCP port 5001
TCP window size: 170 KByte (WARNING: requested 85.0 KByte)
-----
[ 3] local 192.168.10.1 port 43074 connected with 192.168.10.124 port 5001
[ ID] Interval      Transfer    Bandwidth
[ 3] 0.0- 2.0 sec  14.0 MBytes 58.7 Mbits/sec
[ 3] 2.0- 4.0 sec  22.0 MBytes 92.3 Mbits/sec
[ 3] 4.0- 6.0 sec  20.0 MBytes 83.9 Mbits/sec
[ 3] 6.0- 8.0 sec  22.0 MBytes 92.3 Mbits/sec
[ 3] 8.0-10.0 sec  22.0 MBytes 92.3 Mbits/sec
[ 3] 10.0-12.0 sec 20.0 MBytes 83.9 Mbits/sec
[ 3] 12.0-14.0 sec 22.0 MBytes 92.3 Mbits/sec
[ 3] 14.0-16.0 sec 20.0 MBytes 83.9 Mbits/sec
[ 3] 16.0-18.0 sec 22.0 MBytes 92.3 Mbits/sec
[ 3] 18.0-20.0 sec 22.0 MBytes 92.3 Mbits/sec
[ 3] 20.0-22.0 sec 20.0 MBytes 83.9 Mbits/sec
[ 3] 22.0-24.0 sec 20.0 MBytes 83.9 Mbits/sec
[ 3] 24.0-26.0 sec 20.0 MBytes 83.9 Mbits/sec
[ 3] 26.0-28.0 sec 20.0 MBytes 83.9 Mbits/sec
[ 3] 28.0-30.0 sec 20.0 MBytes 83.9 Mbits/sec
[ 3] 30.0-32.0 sec 20.0 MBytes 83.9 Mbits/sec
[ 3] 32.0-34.0 sec 20.0 MBytes 83.9 Mbits/sec
[ 3] 34.0-36.0 sec 20.0 MBytes 83.9 Mbits/sec
[ 3] 36.0-38.0 sec 22.0 MBytes 92.3 Mbits/sec
[ 3] 38.0-40.0 sec 16.0 MBytes 67.1 Mbits/sec
[ 3] 40.0-42.0 sec 20.0 MBytes 83.9 Mbits/sec
[ 3] 42.0-44.0 sec 18.0 MBytes 75.5 Mbits/sec
[ 3] 44.0-46.0 sec 22.0 MBytes 92.3 Mbits/sec
[ 3] 46.0-48.0 sec 20.0 MBytes 83.9 Mbits/sec
[ 3] 48.0-50.0 sec 22.0 MBytes 92.3 Mbits/sec
[ 3] 50.0-52.0 sec 20.0 MBytes 83.9 Mbits/sec
[ 3] 52.0-54.0 sec 20.0 MBytes 83.9 Mbits/sec
[ 3] 54.0-56.0 sec 20.0 MBytes 83.9 Mbits/sec
[ 3] 56.0-58.0 sec 22.0 MBytes 92.3 Mbits/sec
[ 3] 58.0-60.0 sec 22.0 MBytes 92.3 Mbits/sec
[ 3] 60.0-62.0 sec 20.0 MBytes 83.9 Mbits/sec
[ 3] 62.0-64.0 sec 22.0 MBytes 92.3 Mbits/sec
[ 3] 64.0-66.0 sec 22.0 MBytes 92.3 Mbits/sec
[ 3] 66.0-68.0 sec 22.0 MBytes 92.3 Mbits/sec
[ 3] 68.0-70.0 sec 22.0 MBytes 92.3 Mbits/sec
[ 3] 70.0-72.0 sec 20.0 MBytes 83.9 Mbits/sec
[ 3] 72.0-74.0 sec 22.0 MBytes 92.3 Mbits/sec
[ 3] 74.0-76.0 sec 22.0 MBytes 92.3 Mbits/sec
[ 3] 76.0-78.0 sec 22.0 MBytes 92.3 Mbits/sec
[ 3] 78.0-80.0 sec 20.0 MBytes 83.9 Mbits/sec
[ 3] 80.0-82.0 sec 22.0 MBytes 92.3 Mbits/sec
[ 3] 82.0-84.0 sec 22.0 MBytes 92.3 Mbits/sec
[ 3] 84.0-86.0 sec 22.0 MBytes 92.3 Mbits/sec
[ 3] 86.0-88.0 sec 20.0 MBytes 83.9 Mbits/sec
[ 3] 88.0-90.0 sec 22.0 MBytes 92.3 Mbits/sec
[ 3] 90.0-92.0 sec 20.0 MBytes 83.9 Mbits/sec
[ 3] 92.0-94.0 sec 22.0 MBytes 92.3 Mbits/sec
```

Figure 18 – iperf Results (TCP)

```

File Edit View Terminal Help
mindaugas@mindaugas-desktop:~$ iperf -c 192.168.10.1 -u -b 95M -t 38 -i 2 -d -w 110k
-----
Server listening on UDP port 5001
Receiving 1470 byte datagrams
UDP buffer size: 220 KByte (WARNING: requested 110 KByte)
-----
Client connecting to 192.168.10.1, UDP port 5001
Sending 1470 byte datagrams
UDP buffer size: 220 KByte (WARNING: requested 110 KByte)
-----
[ 4] local 192.168.10.1 port 46203 connected with 192.168.10.1 port 5001
[ 3] local 192.168.10.1 port 5001 connected with 192.168.10.1 port 46203
[ ID] Interval      Transfer      Bandwidth
[ 4] 0.0- 2.0 sec  22.8 MBytes  95.6 Mbits/sec
[ 3] 0.0- 2.0 sec  22.8 MBytes  95.6 Mbits/sec  0.006 ms  0/16260 (0%)
[ 4] 2.0- 4.0 sec  22.8 MBytes  95.6 Mbits/sec
[ 3] 2.0- 4.0 sec  22.8 MBytes  95.6 Mbits/sec  0.000 ms  0/16260 (0%)
[ 4] 4.0- 6.0 sec  22.8 MBytes  95.6 Mbits/sec
[ 3] 4.0- 6.0 sec  22.8 MBytes  95.6 Mbits/sec  0.000 ms  0/16260 (0%)
[ 4] 6.0- 8.0 sec  22.8 MBytes  95.6 Mbits/sec
[ 3] 6.0- 8.0 sec  22.7 MBytes  95.1 Mbits/sec  0.001 ms  86/16260 (0.53%)
[ 4] 8.0-10.0 sec  22.8 MBytes  95.6 Mbits/sec
[ 3] 8.0-10.0 sec  22.8 MBytes  95.6 Mbits/sec  0.001 ms  0/16261 (0%)
[ 4] 10.0-12.0 sec  22.8 MBytes  95.6 Mbits/sec
[ 3] 10.0-12.0 sec  22.8 MBytes  95.6 Mbits/sec  0.002 ms  0/16260 (0%)
[ 4] 12.0-14.0 sec  22.8 MBytes  95.6 Mbits/sec
[ 3] 12.0-14.0 sec  22.8 MBytes  95.6 Mbits/sec  0.003 ms  0/16260 (0%)
[ 4] 14.0-16.0 sec  22.8 MBytes  95.6 Mbits/sec
[ 3] 14.0-16.0 sec  22.8 MBytes  95.6 Mbits/sec  0.000 ms  0/16260 (0%)
[ 4] 16.0-18.0 sec  22.8 MBytes  95.6 Mbits/sec
[ 3] 16.0-18.0 sec  22.7 MBytes  95.1 Mbits/sec  0.001 ms  88/16260 (0.54%)
[ 4] 18.0-20.0 sec  22.8 MBytes  95.6 Mbits/sec
[ 3] 18.0-20.0 sec  22.7 MBytes  95.0 Mbits/sec  0.001 ms  101/16260 (0.62%)
[ 4] 20.0-22.0 sec  22.8 MBytes  95.6 Mbits/sec
[ 3] 20.0-22.0 sec  22.7 MBytes  95.0 Mbits/sec  0.000 ms  101/16261 (0.62%)
[ 4] 22.0-24.0 sec  22.8 MBytes  95.6 Mbits/sec
[ 3] 22.0-24.0 sec  22.8 MBytes  95.6 Mbits/sec  0.004 ms  0/16260 (0%)
[ 4] 24.0-26.0 sec  22.8 MBytes  95.6 Mbits/sec
[ 3] 24.0-26.0 sec  22.8 MBytes  95.6 Mbits/sec  0.001 ms  0/16260 (0%)
[ 4] 26.0-28.0 sec  22.8 MBytes  95.6 Mbits/sec
[ 3] 26.0-28.0 sec  22.8 MBytes  95.6 Mbits/sec  0.000 ms  0/16260 (0%)
[ 4] 28.0-30.0 sec  22.8 MBytes  95.6 Mbits/sec
[ 3] 28.0-30.0 sec  22.8 MBytes  95.6 Mbits/sec  0.001 ms  0/16260 (0%)
[ 4] 30.0-32.0 sec  22.8 MBytes  95.6 Mbits/sec
[ 3] 30.0-32.0 sec  22.8 MBytes  95.6 Mbits/sec  0.000 ms  0/16260 (0%)
[ 4] 32.0-34.0 sec  22.8 MBytes  95.6 Mbits/sec
[ 3] 32.0-34.0 sec  22.8 MBytes  95.6 Mbits/sec  0.001 ms  0/16261 (0%)
[ 4] 34.0-36.0 sec  22.8 MBytes  95.6 Mbits/sec
[ 3] 34.0-36.0 sec  22.8 MBytes  95.6 Mbits/sec  0.001 ms  0/16260 (0%)
[ 4] 36.0-38.0 sec  22.8 MBytes  95.6 Mbits/sec
[ 4] 0.0-38.0 sec  433 MBytes  95.6 Mbits/sec
[ 4] Sent 308944 datagrams
[ 3] 36.0-38.0 sec  22.8 MBytes  95.6 Mbits/sec  0.000 ms  0/16260 (0%)

```

Figure 19 – iperf Results (UDP)

Step 4. If test results are meeting the requirement and are no configuration will be done Transmit power should be increased, before mounting PTP units outside. Note that if the distance between the units is short, do not set Transmit Power to the maximum value. Observe the *Signal Indicator* bar – if it is red, decrease the Transmit Power.

PTP Link Establishment

This chapter provides instructions how to install a Point to Point link. A Point to Point link operates in pairs of two units with the same configuration. Both units must be installed, and the antennas aligned for maximum throughput.

Mounting the PTP Unit

The PTP unit's mounting bracket is designed to make installation on a wall or a pipe easy. The unit is attached and its position is fixed with the single bolt.

- Step 1.** Make sure that the PTP unit is powered-off.
- Step 2.** Ground the PTP unit. The PTP unit must be properly grounded to protect against lightning. Note that if the PTP unit is attached to a metal pipe which is earth-grounded, no further grounding is required. If the PTP unit is not earth-grounded via the mounting bracket, the grounding wire must be attached to the grounding stud on the unit as shown in the *Figure 6 – PTP Unit's Back Panel Diagram*.
- Step 3.** Mount the unit onto the pipe or wall (Refer to the appropriate sections *Mounting on a Pipe* or *Mounting on a Wall* on instructions on the selected installation).
- Step 4.** Connect the unit to the bracket together and tighten the nut and bolt.
- Step 5.** Ensure that the unit is oriented so that the cable connectors are at the bottom.
- Step 6.** Power-up the unit.



Avoid standing directly in front of an operating antenna.

Mounting on a Pipe

The PTP unit's mounting bracket may be mounted on pipes with diameters in the range 25mm (1") to 76mm (3"). The PTP units are supplied with mounting hardware for pipe installations.

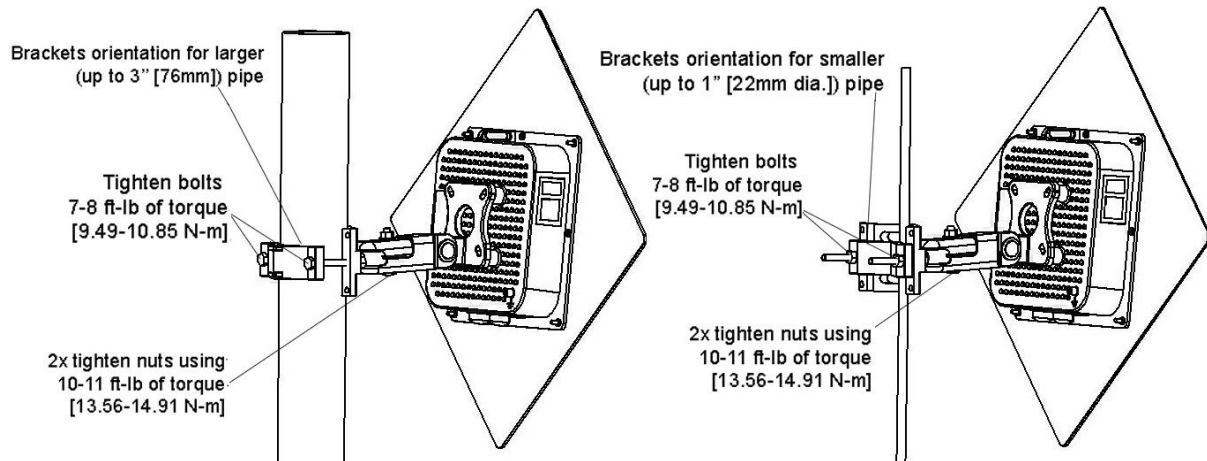

Figure 20 – PTP Unit Mounting on Large and Small Pipes



It is recommended not to tighten the units to its mounting brackets until the alignment process of the antenna is complete.

Mounting on a Wall



The mounting bolts for unit installation on the wall are not included in the package.

For mounting PTP unit on the wall, first mount one half of the bracket to the wall and then connect the two halves of the bracket together and tighten the nut and bolt.

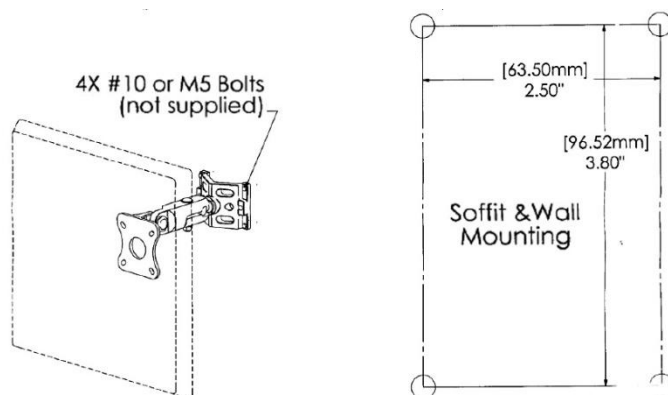

Figure 21 – PTP Unit Mounting on the Wall



It is recommended not to tighten the units to its mounting brackets until the alignment process of the antenna is complete.

Align Antenna



Avoid standing directly in front of an operating antenna while aligning.

The PTP units are equipped with two signal strength feedback systems: antenna alignment tool on the Web management interface and antenna alignment tool on the OLED screen. Follow the steps to establish a radio link between the two PTP units and align the units for the best signal strength.

- Step 1.** Ensure that power is supplied to both PTP link units.
- Step 2.** Ensure normal operation of the unit: check the OLED screen or Status page on the Web management interface.
- Step 3.** Run the **Antenna Alignment** tool on the selected interface (OLED or Web management) and move the antenna in the horizontal and vertical planes until the maximum RSSI visible on the Antenna Alignment graph is achieved.

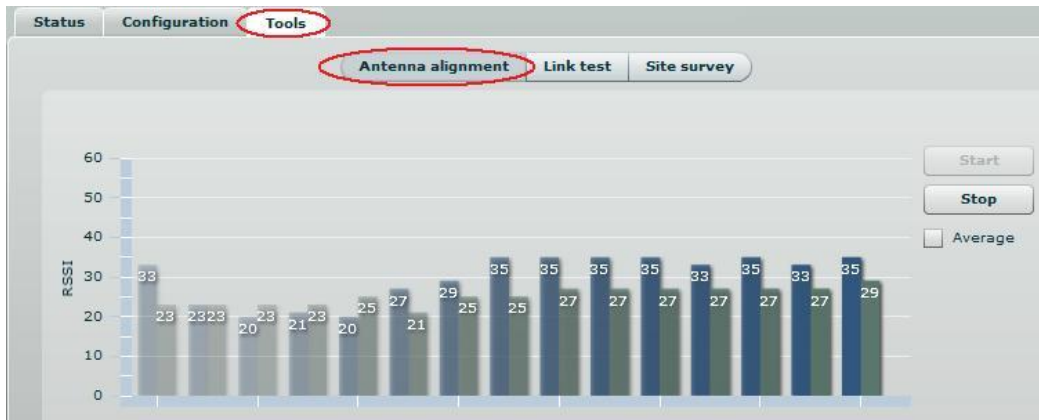

Figure 22 – Antenna Alignment Tool on Web Management Interface



Figure 23 – Antenna Alignment Tool on OLED



For detailed instructions on Antenna Alignment tool, refer to the respective sections:

- Web management – *Antenna Alignment*
- OLED screen – *Run Antenna Alignment*

- Step 5.** After the maximal RSSI is reached, tighten down the unit in the optimum position.

Web Management

PTP products are designed to provide superior performance at long range distances. With a proprietary wireless driver that was written for the sole purpose of optimizing wireless point to point links, one can achieve much higher throughput, especially at longer links, than standards based products.

General Operation

This section provides information about concepts used in PTP unit's Web management interface.

Instant Changes

Some of the PTP radio parameters do not require to reboot the device. These parameters are named as **instant** changes.

Instant changes are useful for best performance parameters tuning. These parameters will take effect as soon as the Apply button is clicked. When best configuration is founded press **Save** button and reboot the device to make changes permanent. Otherwise all instant parameter changes will be lost during PTP unit reboot.

Instant changes are on the *Radio* section.

System Warnings and Errors

There are 3 types of system messages that must be noted: notifications, warnings and error messages. These messages appear at the bottom of the page and can be closed by clicking the sign .

For example notification messages are displayed in brown color and contain information about configuration changes:



Figure 24 – Notification Message (1)

This message has an implemented Reboot button. Simply click this button and the PTP unit will be rebooted at once – there is no need to navigate into the *Maintenance* page for additional action to reboot the unit.

Notification messages also are on Wireless page Instant changes. This message informs you about instant changes that were made:



Figure 25 – Notification Message (2)

Warning messages are displayed in red and contain PTP unit's system cautions:

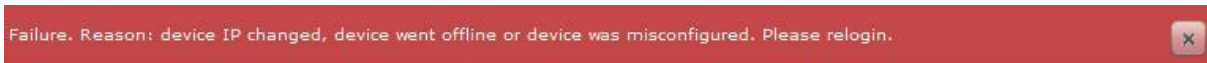

Figure 26 – Warning Message

The PTP unit contains built in validation for configuration settings in the web management interface. If a user sets an incorrect value in the entry field, its frame turns red, and if the user tries to save such incorrect configuration, an error message appears at the end of the page:

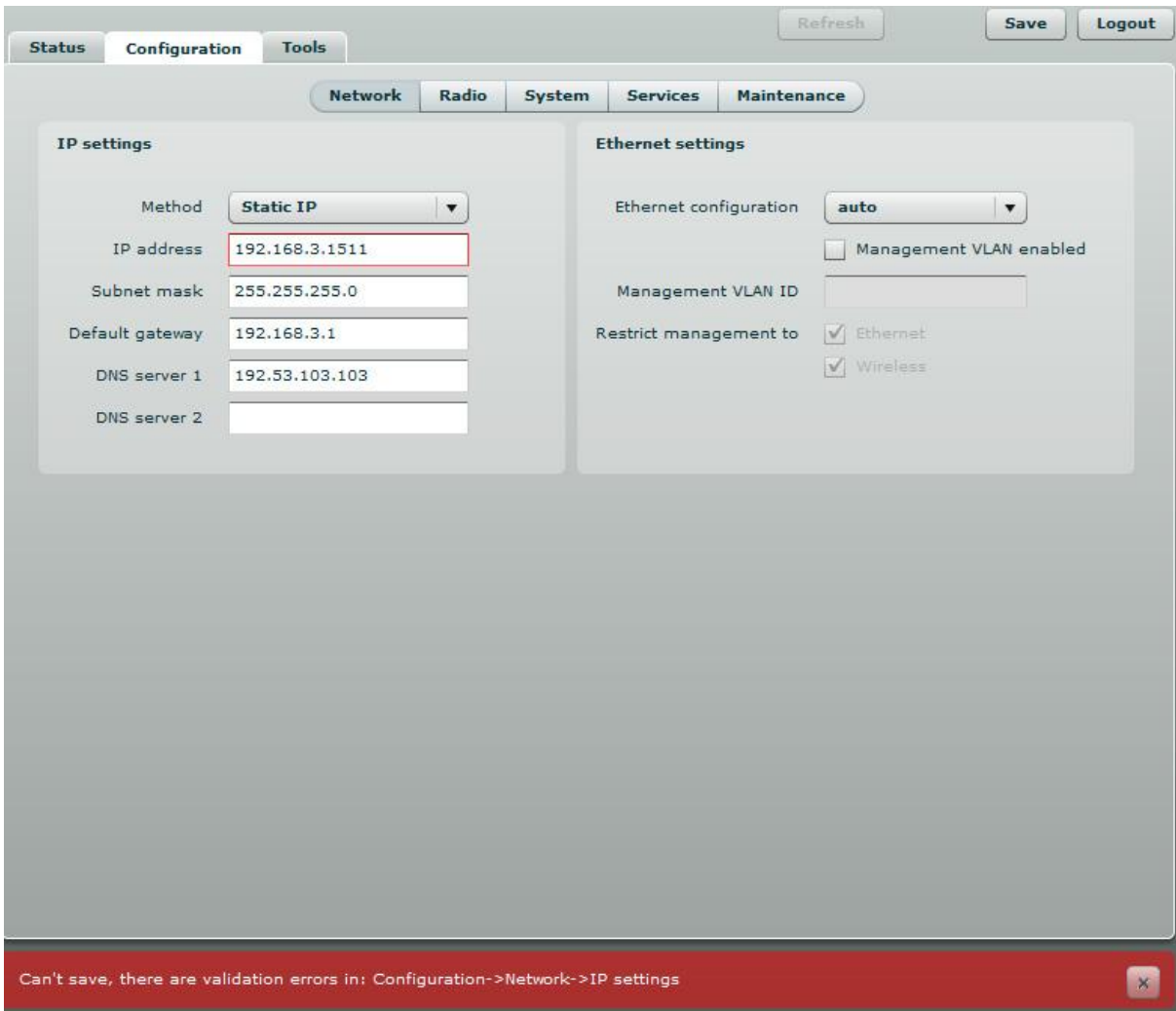

Figure 27 – Error Message

Signal Indicator

The PTP web management interface has a PTP link signal indicator. This indicator displays real-time signal level in dBm of the Local and Remote units.



Figure 28 – PTP Signal Indicator

The color of the Signal indicator will change according to the signal level quality of the unit. The green color means excellent link quality while the red color of the indicator means that link quality is poor.

The red circle ● beside full filled red indicator switches on immediately when the signal level becomes too high and overload is detected.



Figure 29 – PTP Signal Indicator (too Strong Signal)

This may happen on an incorrect link layout, for example, in the case when the TX power parameter in the PTP units is set to maximum but physically the units are too close to each other (e.g. testing units are placed on a table).

The screenshot below displays Signal indicator if there is no PTP link established between PTP units:



Figure 30 – PTP Signal Indicator (no Link Established)

Status

Use the Status menu to check the current status of the PTP unit and established link (this is the default page when accessing the device's web management interface). The Information page displays generic information and status of the PTP unit. The page is divided into three main categories: System, Network and Wireless. The System section displays the identification information of the PTP unit. The Wireless section presents main wireless settings. The Ethernet section describes the PTP unit's network identity and connectivity.

The information in the page can be updated using **Refresh** button.

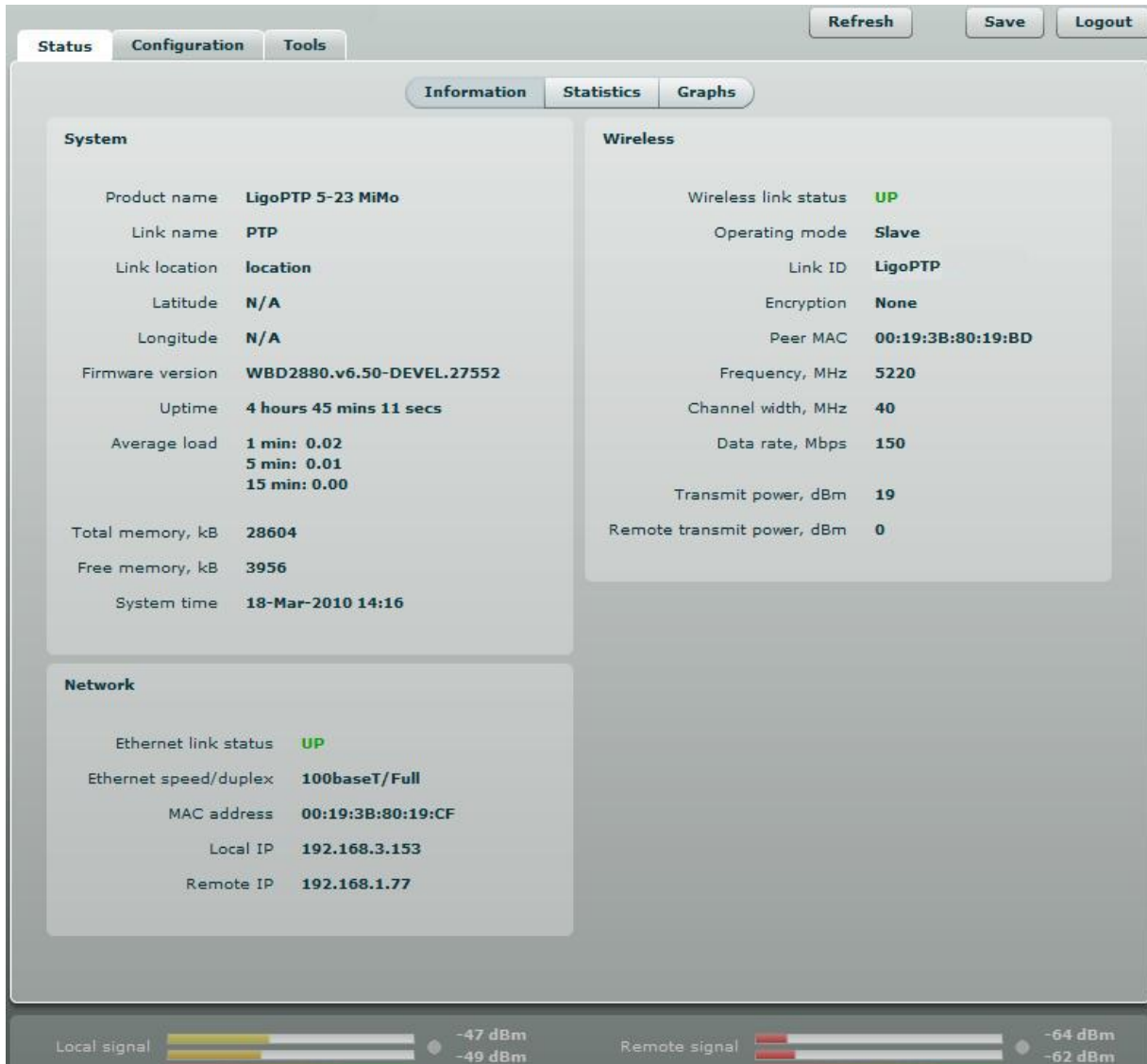

Figure 31 – Status Page

System

System section displays general information of the PTP unit.

Product name – displays the product name.

Link name – displays the link name which is used to identify the PTP unit on the network.

Link location – displays the link location, which is used to identify the PTP unit on the network.

Latitude – displays the latitude coordinates of the device.

Longitude – displays the longitude coordinates of the device.

Firmware version – displays the device hardware and software version.

Uptime – displays the time, expressed in days, hours and minutes since the system was last rebooted.

Average load – displays the average load of the device processor in the period of the last 1 minute, 5 minutes and 15 minutes (a larger value means a larger average load on the processor).

<1.0 – System is idle

=1.0 – Normal load

>1.0 – Processor is busy.

Total memory, kB – displays total system memory.

Free memory, kB – displays free system memory.

System time – displays current system time.

Network

Ethernet link status – displays the status of the Ethernet link. A State **UP** indicates that the Ethernet link is established. A state **DOWN** indicates that the Ethernet link is not established.

Ethernet speed/duplex – displays the negotiated speed and duplex of the Ethernet interface specified in Mbps. The N/A will be displayed if the Ethernet status is down. Full duplex means that data can be transmitted in both directions on a signal carrier at the same time. Half duplex means that data can be transmitted in both directions on a signal carrier, but not at the same time. Auto means that the system will detect link speed and duplex mode automatically.

MAC address – displays MAC address of the device.

Local IP – displays IP address of the local unit.

Remote IP – displays IP address of the remote unit. The N/A will be displayed if there is no PTP link established.

Wireless

Wireless link status – displays the status of the Wireless link. A State **UP** indicates that the Wireless link between local and remote units is established. A state **DOWN** indicates that the Wireless link between local and remote units is not established.

Operating mode – displays the operating mode of the device. The operating mode can be Master or Slave.

Link ID – displays PTP link ID, specified by the user.

Encryption – displays encryption method: none or AES.

Peer MAC – displays MAC address of the remote unit.

Frequency, MHz – displays frequency in MHz at which the PTP link communicates.

Channel width, MHz – displays the channel width (5/10/20/40) at which the PTP link communicates.

Data rate, Mbps – displays the data rate at which the PTP link communicates.

Transmit power, dBm – displays TX power value of the local PTP unit.

Remote transmit power, dBm – displays TX power value of the remote PTP unit.

Statistics

The statistics page displays detailed statistics of the PTP link performance. The Statistics page is divided into the two sections: Networks statistics and W-Jet statistics.

Network statistics contains detailed statistics of Ethernet and Wireless interfaces:

Information Statistics Graphs								
Network statistics								
Interface	RX bytes	RX packets	RX errors	RX drops	TX bytes	TX packets	TX errors	TX drops
Ethernet	340412	3309	0	0	543723	2518	0	0
Wireless	260561	1228	0	0	215601	1825	0	0

Figure 32 – Statistics Page

RX bytes - displays the total number of received bytes by the Ethernet or Wireless interface of the PTP link.

RX packets - displays the total number of received packets by the Ethernet or Wireless interface of the PTP link.

RX errors - displays the total number of received corrupted packets by the Ethernet or Wireless interface of the PTP link.

RX drops - displays the total number of dropped packets by the Ethernet or Wireless interface of the PTP link.

TX bytes - displays the total number of sent bytes by the Ethernet or Wireless interface of the PTP link.

TX packets - displays the total number of sent packets by the Ethernet or Wireless interface of the PTP link.

TX errors - displays the total number of sent corrupted packets by the Ethernet or Wireless interface of the PTP link.

TX drops - displays the total number of dropped packets by the Ethernet or Wireless interface of the PTP link.

W-Jet statistics displays detailed statistics of PTP link communication protocol.

W-Jet statistics			
Local name	Local value	Remote name	Remote value
Rx bytes	56920623 (+10159670)	Tx bytes	13507210 (0)
Tx bytes	178475 (0)	Rx bytes	28624065 (0)
Rx packets	348678 (+63369)	Tx packets	16763 (0)
Tx packets	777 (0)	Rx packets	698078 (0)
Tx packets fail	0 (0)	Tx packets fail	4 (0)
Tx packets retry	0 (0)	Tx packets retry	7411 (0)
Rx duplicated packets	21 (+5)	Rx duplicated packets	0 (0)
CRC errors	0 (0)	CRC errors	0 (0)

Figure 33 – W-Jet Statistics

Local – statistics of the Local unit.

Remote – statistics of the Remote unit.

Rx bytes – number of transmitted bytes. The number in brackets (+xx) displays the data change since the last page refresh.

Tx bytes – number of the received bytes. The number in brackets (+xx) displays the data change since the last page refresh.

Rx packets – number of received data packets The number in brackets (+xx) displays the data change since the last page refresh.

Tx packets – number of transmitted data packets. The number in brackets (+xx) displays the data change since the last page refresh.

Tx packets fail – number of failed to transmit packets. The number in brackets (+xx) displays the data change since the last page refresh.

Tx packets retry – total number of attempts to retransmit data packets. The number in brackets (+xx) displays the data change since the last page refresh.

RX duplicated packets – the number of received duplicated packets. The number in brackets (+xx) displays the data change since the last page refresh.

CRC errors – the total number of CRC errors. The number in brackets (+xx) displays the data change since the last page refresh.

Graphs

The Graphs page contains device statistics in graphic diagrams and is used for device monitoring. Select the required statistics (RSSI, Traffic, RX/TX errors, Memory, CPU load or Frequency change) and the corresponding graphic diagrams will be displayed. The statistics in diagrams are displayed on hourly, daily, weekly, monthly or yearly basis; hourly is chosen by default. The option **Display current time set on the system** gives possibility to convert the time stamps on the diagrams in current date, set on the administrator's PC.

To update statistics data click **Refresh** button.



Point the mouse cursor on the diagram line and you will get the numeric expression of the particular statistic.

RSSI diagram displays RSSI change of the Local and Remote PTP units at the chosen period:

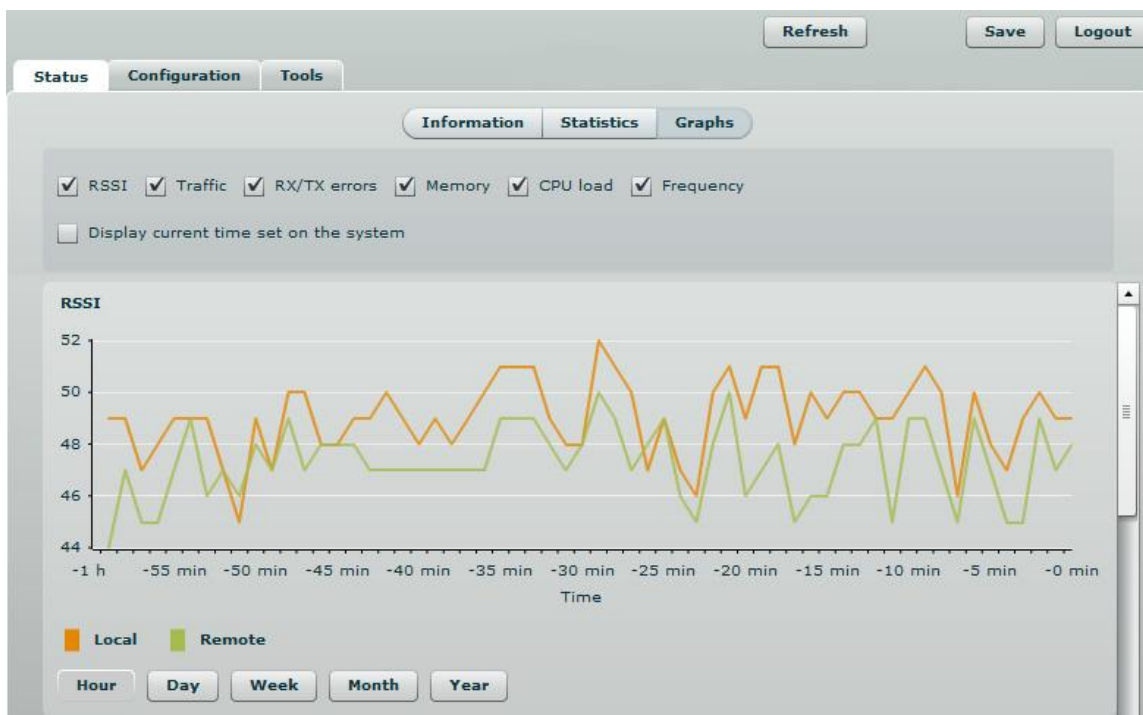

Figure 34 – RSSI Graph

Traffic diagram displays Incoming and Outcoming traffic statistical data:



Figure 35 – Traffic Statistics Graph

RX/TX errors diagram displays statistical data of RX drop of the Local and Remote units, TX try of the Local and Remote units:

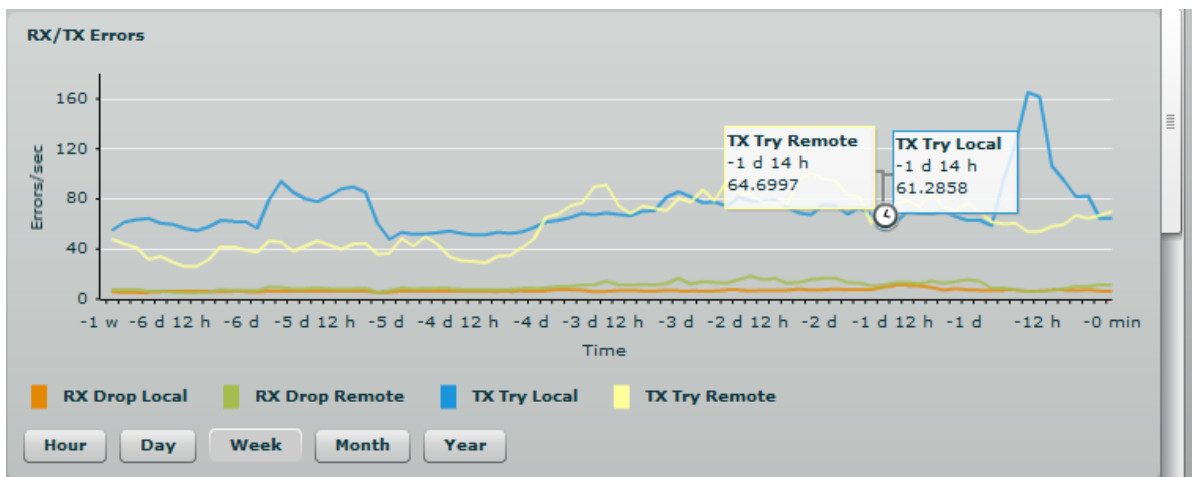

Figure 36 – RX/TX Errors Statistics Graph

Memory diagram displays memory usage data:



Figure 37 – Memory Status Graph

CPU load diagram displays device CPU load in appropriate time basis:

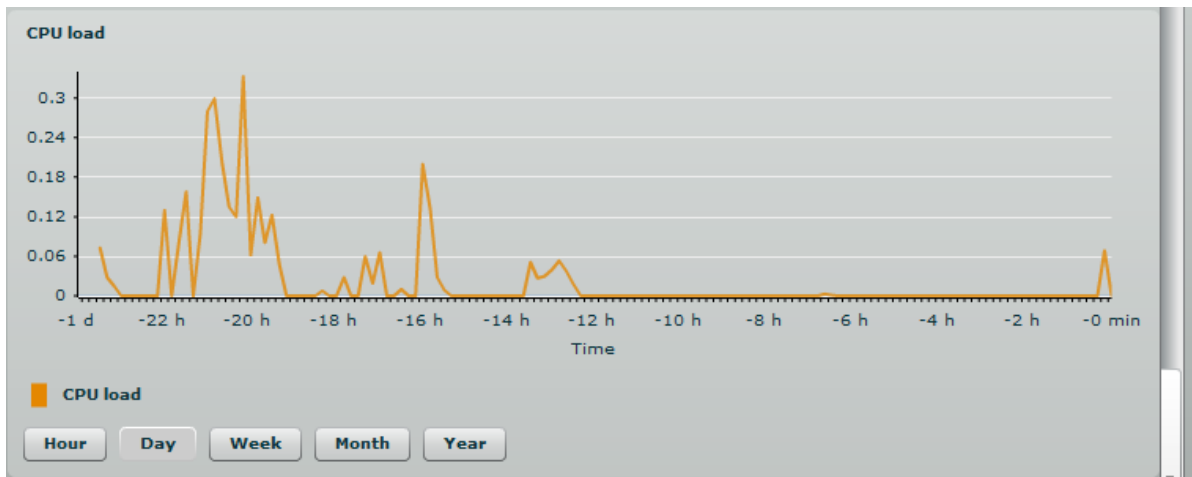

Figure 38 – CPU Load Graph

Frequency diagram displays device operating frequency in GHz:

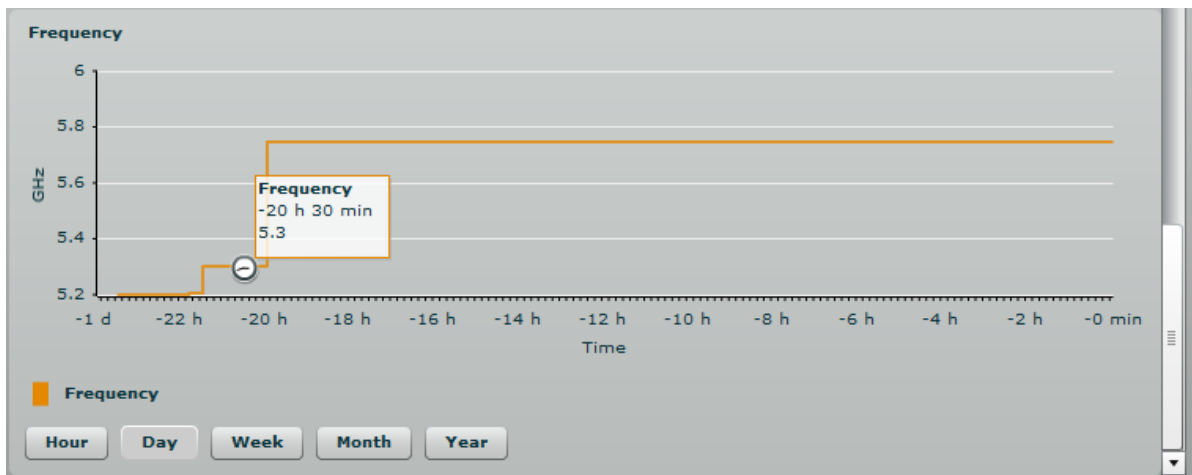

Figure 39 – Frequency Graph at which PTP Link is Operating

Configuration

The Configuration page is subdivided into following pages:

- **Network** – to set main network configuration for PTP device.
- **Radio** – to setup radio settings of the PTP link.
- **System** – to setup system date, administrator's access settings, configure system log feature.
- **Services** – to setup SNMP, RCMS settings and configure device alerts.
- **Maintenance** – for device firmware update, reboot, reset device to factory defaults, troubleshooting file download and to view system log messages.

Network

The network configuration as described below is required for PTP management purposes. Use the **Network** menu to setup the network settings of the PTP unit:

The screenshot shows a web-based configuration interface for a PTP device. At the top, there are buttons for 'Refresh', 'Save', and 'Logout'. Below these are navigation tabs: 'Status', 'Configuration', and 'Tools'. Under 'Configuration', there are sub-tabs: 'Network', 'Radio', 'System', 'Services', and 'Maintenance'. The 'Network' sub-tab is selected. The interface is divided into two main sections: 'IP settings' and 'Ethernet settings'.
IP settings:
- Method: Static IP (dropdown menu)
- IP address: 192.168.3.116
- Subnet mask: 255.255.255.0
- Default gateway: 192.168.3.1
- DNS server 1: 192.168.3.1
- DNS server 2: (empty field)
Ethernet settings:
- Ethernet configuration: auto (dropdown menu)
- Management VLAN enabled:
- Management VLAN ID: 1334
- Restrict management to: Ethernet, Wireless

Figure 40 – Network Settings

Method – specify IP configuration mode:

- **Static IP** – choose to specify static IP of the device.
- **Dynamic IP** – choose to use dynamic IP given by the DHCP server (running DHCP server is required).

IP address – specify the device IP address [digit and dots]. When shipped from the factory or reset to factory settings, device defaults to a static IP address of 192.168.2.66.

Subnet mask – specify the device subnet mask [digit and dots]. When shipped from the factory or reset to factory settings, the device defaults to a subnet mask of 255.255.255.0.

Default gateway – specify the IP address of the device gateway [digit and dots]. When shipped from the factory or reset to factory settings, the device defaults to a gateway IP address of 192.168.2.1.

DNS server 1 – specify the IP address of the primary DNS server [digit and dots]. The DNS (Domain Name Service) service translates Internet host names into their IP addresses.

DNS server 2 – specify the IP address of the secondary DNS server.

Ethernet configuration - configures the Ethernet link speed and the duplex mode of the Ethernet port. Choose "auto" for automatic detection of link speed and duplex mode.

Management VLAN ID – specify the management VLAN ID [2-4094]. If a management VLAN is enabled, all traffic received by the device must be tagged with the management VLAN ID to access the network. All non-tagged traffic will be dropped, thus reducing the risk of unauthorized access.

Restrict management to – select interfaces on which management access will be restricted.

Radio

Use the **Configuration | Radio** menu to set up radio settings for the PTP link:

Figure 41 – Radio Settings

Operating mode – specify the operating mode of the local device to create PTP link [Master/Slave]. The device mode depends on the network topology.

- **Master** – in this mode local device is the controlling PTP link unit.
- **Slave** – in this mode local device connects to the Master unit.

Instant Changes

Applying parameters in the **Instant changes** section does not require device reboot, therefore making easy parameters adjustment for best performance.

Link ID – specify known network name of the remote device to establish a PTP link.



Both sides (Master and Slave units) of the link must have the same **Link ID** name.

Country – from drop-down list choose country in which the devices will operate. According to the chosen country the regulatory domain settings may differ. You are not allowed to select radio channels and RF output power values other than the permitted values for your country and regulatory domain.

Frequency – specify frequency at which the PTP link will be operating. If the device is operating in Slave mode, it will not have the possibility to choose a frequency. The Slave scans the air and connects to the Master automatically.



The available Frequencies list varies depending on the selected **Country** and **Channel width**.

Channel width – choose the channel width in MHz [20/40].



Both sides (Master and Slave) of a link must have the same Link ID, Channel width and Encryption specified.

Encryption – select the security level for the PTP link:

- **None** – means no security on link.
- **AES** – means encryption with passphrase.

Passphrase – specify passphrase of the AES security [8-63 characters]. This parameter appears and is mandatory when AES security is chosen.

Transmit power – set the radio transmit power at which the device will transmit data. The larger the distance, the higher transmit power is required. To set transmit power level use the slider or enter the value manually. The transmit power level that is actually used is limited to the maximum value allowed by your country's regulatory agency.

Multipath protection – if checked the signal will become more robust to signal interference caused by signal echos or reflections. However as the drawback the enabled multipath protection will lead to reduced link capacity.

Mode – choose the PTP antenna operating mode:

SISO – single input single output. The device will use only one antenna for data transfer. The antenna will be chosen automatically.

MIMO – multiple input multiple output. The device will use two antennas for data transfer (two simultaneous streams). In this mode the *link capacity doubles *if compared to SISO mode.

Data rate – select the device data transmission rates in Mbps from the drop-down list.

ACK Timeout – specify the Acknowledgement timeout either in distance, or in time expression:

Distance – specify the distance between PTP units, and ACK timeout will be calculated automatically according the indicated distance in kilometers or miles.

Time – specify the ACK timeout in time expression.

System

The System page is subdivided into 4 sections:

- **Link settings** – to specify PTP link settings.
- **System date** – to setup system date and time of the PTP unit.
- **Administrative account** – to change administrator's password.
- **System log** – to configure logging of the system messages.

Link Settings

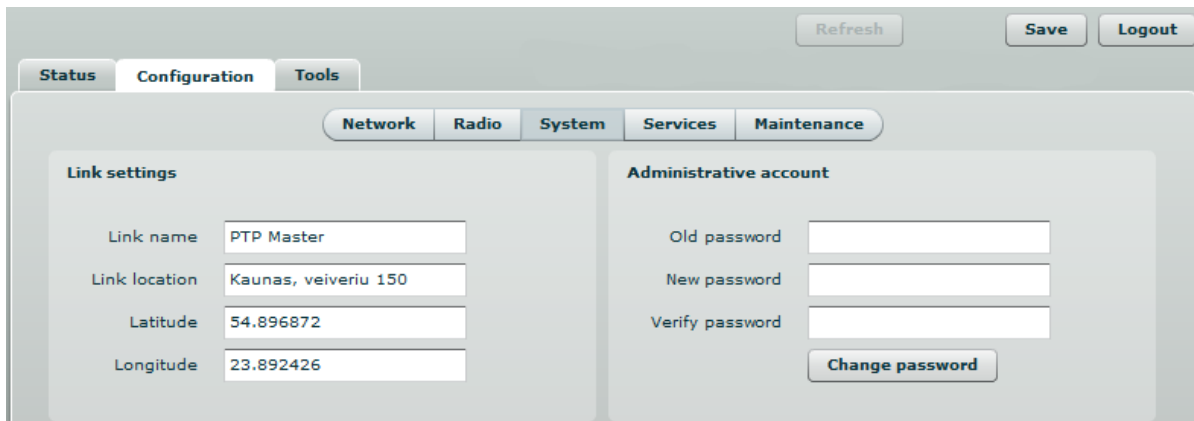

Figure 42 – Link Settings

Link name – specify name of the PTP link that is used to identify the unit on the network [maximum 255 ASCII characters].

Link location – describe the location of the PTP unit [maximum 255 ASCII characters].

Longitude – specify the longitude coordinates of the PTP unit [specific decimal format, e.q. 54.869446].

Latitude – specify the latitude coordinates of the PTP unit [specific decimal format, e.q. 23.891058]. Both coordinates helps indicate accurate location of the PTP unit's.

System Date

Use this section to manage the system time and date on the device automatically, using the Network Time Protocol (NTP), or manually, by setting the time and date on the PTP unit.

The NTP (Network Time Protocol) client synchronizes the clock of the device with the defined time server. Choose NTP from the configuration menu, select your location timezone and enter NTP server in order to use the NTP service:

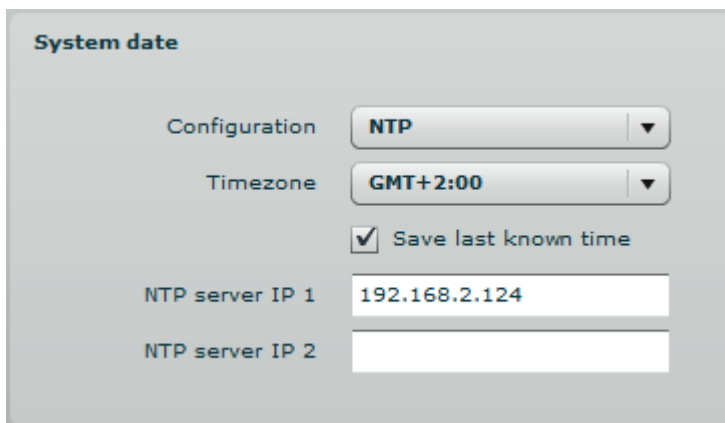

Figure 43 – System Date: NTP Configuration

Configuration – choose the system clock configuration mode [NTP/Manual].

Timezone – select the timezone. Time zone should be specified as a difference between local time and GMT time.

Save last known time – select to recall the timestamp that was saved on last reboot. When NTP is enabled, this option will set system clock to last reboot time if no NTP servers are available.

NTP server – specify the trusted NTP server IP or hostname for synchronizing time with [IP address].

To adjust the clock settings manually, choose the configuration mode as **Manual** and specify the following settings:

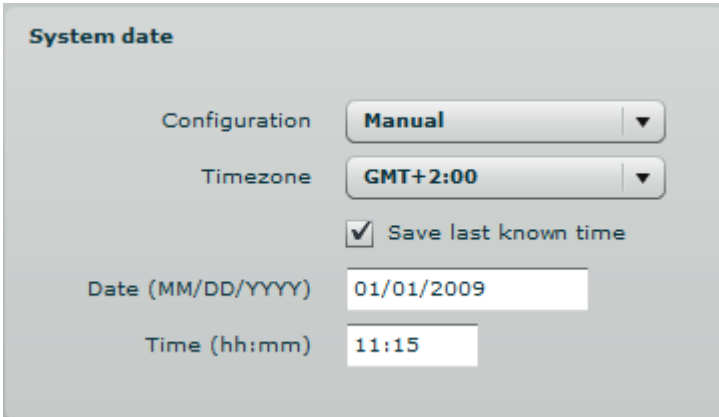

The screenshot shows a configuration window titled "System date". It contains the following fields and controls:

- Configuration:** A dropdown menu set to "Manual".
- Timezone:** A dropdown menu set to "GMT+2:00".
- Save last known time:** A checked checkbox.
- Date (MM/DD/YYYY):** A text input field containing "01/01/2009".
- Time (hh:mm):** A text input field containing "11:15".

Figure 44 – System date: Manual Clock Configuration

Configuration – choose the system clock configuration mode [NTP/Manual].

Timezone – select the timezone. Time zone should be specified as a difference between local time and GMT time.

Save last known time – select to recall the timestamp that was saved on last reboot.

Date – specify the new date value in format MM/DD/YYYY.

Time – specify the time in format hh:mm.



If the device hardware has no internal clock, the configured manual time will be reset to the specified date and time after each device reboot.

Administrative Account



We recommend changing the default administrator password as soon as possible.

The Administrative Account menu is for changing the administrator's password.

Figure 45 – Changing the Administrator's Password

Old password – enter the old administrator password.

New password – enter the new administrator password for user authentication.

Verify password – re-enter the new password to verify its accuracy.



The only way to gain access to the web management if you forget the administrator password is to reset the device to factory default settings.



Default administrator login settings are:

User Name: **admin**

Password: **admin01**

System Log

Use the Configuration | System menu to configure device to save log messages to the local or remote server using standard syslog facility:

Figure 46 – System Log Configuration

Message level – specify system's message tracing level. The level determines the importance of the message and the volume of messages generated by the PTP unit. The levels are in increased importance order [emergency, alert, critical, error, warning, notice, information, debug]. Default: info.

The PTP unit can be configured to send system log messages to a remote server:

Syslog forward – select to enable remote system logging.

Forward server – specify the remote host IP address or hostname where syslog messages will be sent.

Forward port – specify the port to which syslog messages will be forwarded [0-65535]. Default: 514.

Forward message level – specify the message level that will be send to the remote syslog server. The level determines the importance of the message and the volume of messages generated by the PTP unit. The levels are in order of increasing importance [emergency/alert/critical/error/warning/notice/information/debug]. Default: information.

Forward backup – select to enable remote syslog logging backup.

Backup server – specify the backup host IP address or hostname where syslog messages will be send to.

Backup port – specify the port to which syslog messages will be forwarded [0-65535]. Default: 514.



To view logged system messages locally, navigate to the menu *Maintenance*

Services

The Services page is divided into 3 sections:

- **SNMP configuration** – To enable SNMP and setup SNMP on the PTP unit.
- **RCMS configuration** – to enable and setup RCMS agent on the PTP unit.
- **Alerts** – to enable and setup system alerts.

SNMP Configuration

SNMP is the standard protocol that is widely used for remote network management over the Internet. With the SNMP service enabled, the PTP unit can act as SNMP agent.



To communicate with SNMP manager you must configure SNMP communities and identifiers on both ends (manager and agent).

Simple Network Management Protocol (SNMP)	
<input checked="" type="checkbox"/> SNMP enabled	
Link name	PTP Master
Link location	Kaunas, veiveriu 150
Contact information	nr 3706789998765
R/O community	public
R/O user	public
R/O user password	password

Figure 47 – SNMP Settings Configuration

Enable SNMP – specify the SNMP service status.

Name – displays an administratively assigned name.

System location – displays the physical location of the PTP unit [string].

R/O community – specify the read-only community name for SNMP version 1 and version 2c [string]. The read-only community allows a manager to read values, but denies any attempt to change values.

R/O user – specify the user name for read-only SNMPv3 access [string]. The read-only community allows a manager to read values, but denies any attempt to change values.

R/O user password– specify the password for read-only SNMPv3 access [string].

WNMS Configuration

Wireless Network Management System (WNMS) is a centralized monitoring and management system for wireless network equipment. The communication between managed devices and the WNMS server is always initiated by a WNMS agent service running on every device.

Wireless Network Management System (WNMS)

Enable WNMS agent

Server/Collector URL:

Figure 48 – WNMS Agent Configuration

Enable WNMS – select to enable WNMS agent settings.

Server/Collector URL – specify the URL of the WNMS server that heartbeat notifications will be sent to.

System Alerts

The PTP unit is able to send external alerts when there are system errors. The alerts can be sent via SNMP Traps or/and SMTP notifications.

System alerts

System check interval, s:

SNMP	SMTP	Alert description	
<input checked="" type="checkbox"/>	<input checked="" type="checkbox"/>	Wireless link status change	
<input checked="" type="checkbox"/>	<input checked="" type="checkbox"/>	Ethernet link status change	
<input checked="" type="checkbox"/>	<input checked="" type="checkbox"/>	RSSI level low than	<input type="text" value="25"/>
<input checked="" type="checkbox"/>	<input checked="" type="checkbox"/>	Noise level greater than, dBm	<input type="text" value="-60"/>
<input checked="" type="checkbox"/>	<input checked="" type="checkbox"/>	RX drop greater than, %	<input type="text" value="35"/>
<input checked="" type="checkbox"/>	<input checked="" type="checkbox"/>	TX retry greater than, %	<input type="text" value="35"/>
<input checked="" type="checkbox"/>	<input checked="" type="checkbox"/>	Device reboot	
<input checked="" type="checkbox"/>	<input checked="" type="checkbox"/>	DFS channel change	

SNMP traps settings

Manager address:

Manager port:

Trap community:

Use inform

Retry count:

Retry timeout:

SMTP settings

Server address:

Server port:

Source e-mail address:

Destination e-mail address:

E-mail notification interval, s:

Figure 49 – System Alerts Configuration

Enable alerts – select to enable alert notifications on the system.

System check interval, s – specify interval in seconds at which the device will send notifications of unexpected system behavior.

System alerts:

- **Wireless link status change** – system will send notification on Wireless link status change.
- **Ethernet link status change** – system will send notification on Ethernet link status change.
- **RSSI level lower than** – system will send notification when RSSI reach value lower than specified. Default: 25.
- **Noise level greater than** – system will send notification when signal noise will reach value greater than specified. Default: -60 dBm.
- **RX drop greater than** – system will send notification when the specified percent of RX dropped packets becomes higher than specified value. Default: 250 packets per seconds.
- **TX retry greater than** – system will send notification when the specified percent of TX retries becomes higher than specified value. Default: 250 packets per seconds.
- **Device reboot** – system will send notification about unexpected or administrator initiated device reboot.
- **DFS channel change** – system will send notification on DFS channel change.

SNMP Traps Settings

Manager address – specify the IP address or hostname of Trap receiver.

Manager port – specify the port number of the Trap receiver. Default port number is 162.

Trap community – specify the SNMP community string. This community string acts as password between SNMP manager and PTP unit. by default Trap community string is "public".

Use inform – select to wait for an acknowledgment from SNMP manager that trap was received.

Retry count – specifies maximum number of times to resend an inform request [1-10]. Default: 5.

Retry timeout – specifies number in seconds to wait for an acknowledgment before resending request [1-10]. Default: 1.

SMTP Settings

Server address – specify the IP address or hostname of the networked SMTP server.

Server port – specify the SMTP Port Number is the port number used by the networked SMTP server. By default the port number is 25.

Source e-mail – specify the e-mail address that will be used by the PTP unit.

Destination e-mail – specify the e-mail address where the PTP unit will send the alert messages.

E-mail notification interval – specify interval in seconds at which the e-mail notification will be sent from the PTP unit [0-86400]. If 0 specified, then device will send an e-mail notification immediately after unexpected system behavior.

Maintenance

Use Maintenance menu for device firmware update, reboot, reset device to factory defaults, troubleshooting file download, view system log messages and control OLED.

System Functions

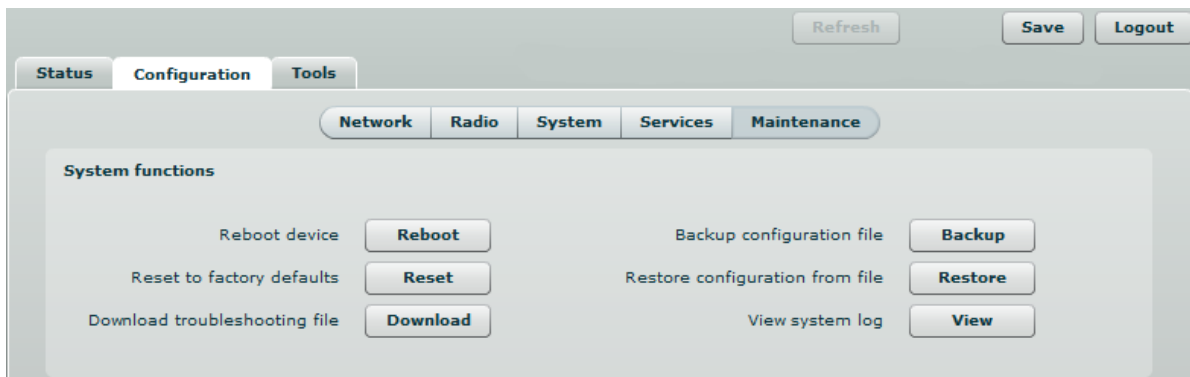

Figure 50 – Main System Functions

Reboot device – reboot device with the last saved configuration.

Reset device to factory defaults – click to restore unit's factory configuration values.



Resetting the device is an irreversible process. Current configuration and the administrator password will be set back to the factory default.

Download troubleshooting file – click to download the troubleshooting file. The troubleshooting file contains valuable information about device configuration, routes, log files, command outputs, etc. When using the **troubleshooting file**, the device quickly gathers troubleshooting information automatically, rather than requiring you to gather each piece of information manually.. This is helpful for submitting problems to the support team.

Backup configuration file - click to save the current configuration file. The saved configuration file is useful to restore a configuration in case of a device misconfiguration or to upload a standard configuration to multiple devices without the need to manually configure each device through the web interface..

Restore configuration from file - click to upload an existing configuration file to the device.

View system log - click to view current trace messages. The Syslog viewer utility provides debug information about the system services and protocols. If the device's malfunction occurs recorded messages can help operators to locate misconfiguration and system errors. The syslog capability can help operators to locate misconfiguration and system errors.

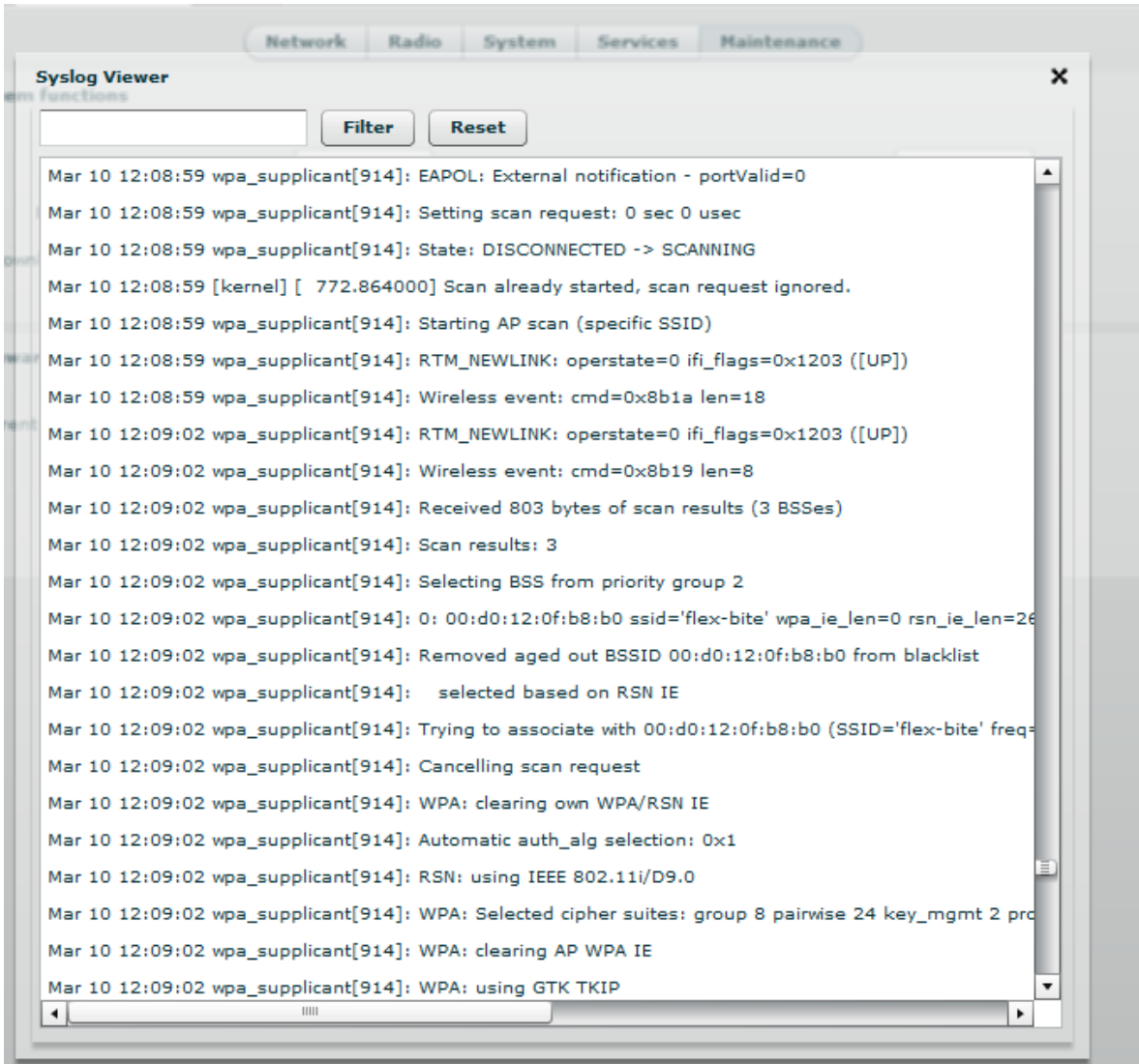

Figure 51 – System Log Viewer

Filter – filter content of the system messages by entering required words or symbols.



To change level of the system messages displayed in the Syslog viewer use menu *System Log*.

OLED Control

Use this section under Maintenance tab to control status or assign a PIN code for the PTP unit's OLED:



Figure 52 – OLED Control

Enable OLED – select to enable or disable OLED on the PTP unit.

PIN required – select to enable or disable OLED protection with PIN.

PIN – enter 4 digits for OLED protection.

Firmware Upgrade

To update your device firmware use the **Firmware upgrade** section under the **Maintenance** menu, select the firmware file and click the **Upload** button:

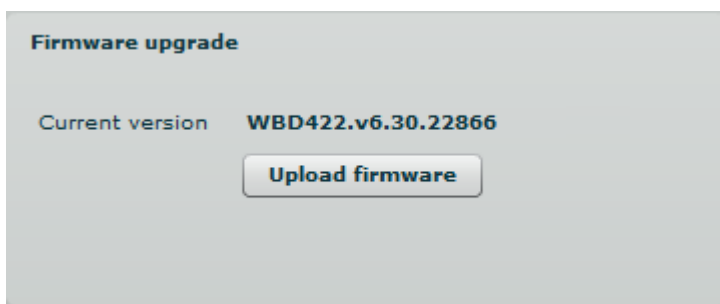

Figure 53 – Firmware Upload on the System

Current version – displays version of the current firmware.

Upload firmware – click the button to select the new firmware image for uploading it to the device..

The device system firmware upgrade is compatible with all configuration settings. When the device is upgraded with a newer version or the same version builds, all the system's configuration will be preserved after the upgrade.

The new firmware image is uploaded to the controller's temporary memory. It is necessary to save the firmware into the device permanent memory. Click the **Upgrade** button:

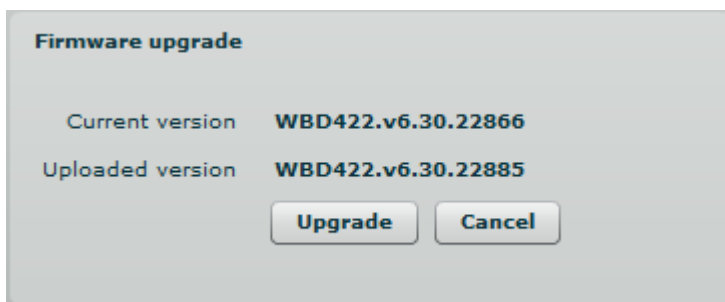

Figure 54 – Firmware Upgrade

Upgrade – upgrade device with the uploaded image and reboot the system.



Do not switch off and do not disconnect the device from the power supply during the firmware update process as the device could be damaged.

Tools

Use the Tools menu to use the following device applications:

- **Site survey** – to view the list of wireless networks in the surrounding area.
- **Antenna alignment** – to align device antenna.
- **Link test** – to check quality of the established PTP link.

Antenna Alignment

The antenna alignment test measures signal quality between the Master and Slave units. For best results during the antenna alignment test, turn off all wireless networking devices within range of the device except the device(s) with which you are trying to align the antenna. Watch the constantly updated display in the antenna alignment test window as you adjust the antenna.

The Antenna Alignment test results appear when you click the **Start** button and finishes when you click the **Stop** button.

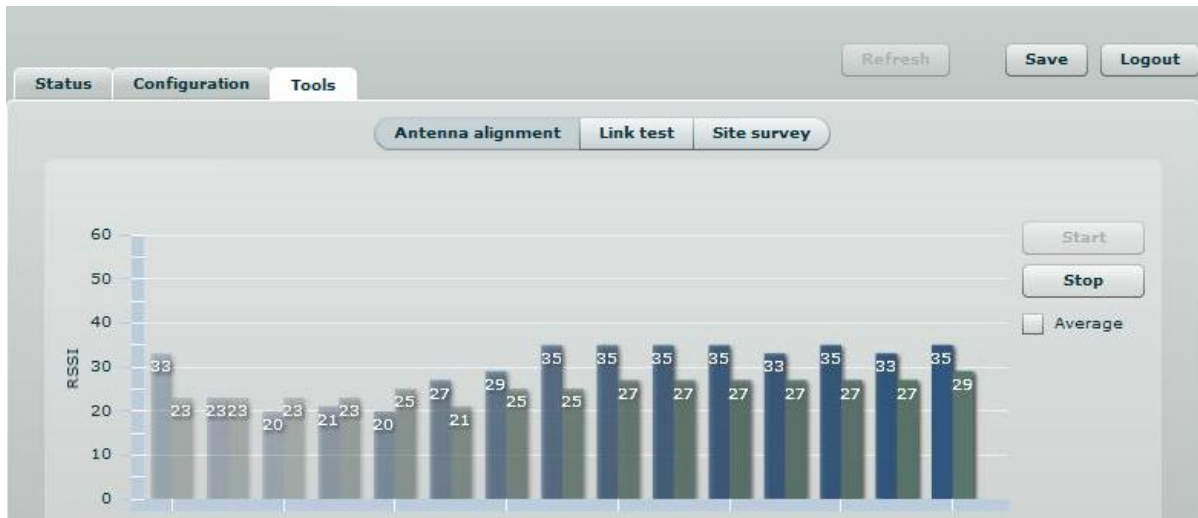

Figure 55 – Antenna Alignment Tool

Average – if this option selected, the graph will display the average RSSI of both antennas.

Site Survey

The **Site Survey** test shows overview information for wireless networks in a local geographic area.

Using this test, an administrator can scan for working access points, check their operating frequency, encryption, see signal/noise levels and view whether device has enabled W-Jet or not. This feature may be used by the administrator find unused wireless channel so that PTP unit would not interference with adjacent working devices thus getting best possible performance.



Note that Site Survey function can take several minutes to perform.

To perform the Site Survey test, click the **Start scan** button:

The screenshot shows a web-based interface for a Site Survey Tool. At the top, there are buttons for 'Refresh', 'Save', and 'Logout'. Below these are tabs for 'Status', 'Configuration', and 'Tools'. Under the 'Tools' tab, there are sub-tabs for 'Antenna alignment', 'Link test', and 'Site survey'. The 'Site survey' sub-tab is active, showing a 'Start scan' button and a checkbox for 'Show only W-Jet AP'. A note states: 'Note: initiating Scan will temporary disable radio link(s) with selected radio.' Below this is a table with the following data:

MAC address	Network name	Encryption	Signal, dBm	Noise, dBm	Frequency, MHz	W-Jet
00:0B:6B:CA:7C:0C	CPE	none	-76	-95	5180	-
00:0B:6B:3E:5D:E3	PTP Link 3	wpa2	-52	-95	5200	yes
00:0B:6B:3E:4A:3C	PTP Link 2	wpa2	-78	-95	5240	yes
00:19:3B:80:69:9E	PTP	none	-53	-95	5275	yes
00:0B:6B:2D:80:68	ServiceSet3-1	none	-91	-95	5280	-
00:0B:6B:2C:FB:3F	ServiceSet4-1	none	-83	-95	5785	-
00:21:A4:00:03:1A	vambzdis	wpa2	-89	-95	5785	yes

At the bottom of the table area, it says 'Last updated before 1:21:22'.

Figure 56 – Site Survey Tool

Start scan – click to perform the Site Survey test.

Show only W-Jet AP – select this option to sort Site Survey results.

Link Test



We recommend to ensure that there is no traffic on the link before running the Link Test as results may not be completely accurate.

Use the Link test tool to check the quality of the established PTP link. This tool tests the throughput at selected packet sizes and iterations. Link test can be run from either the Remote unit or Local unit. Results represent the maximum, minimum and average value of the performed test.

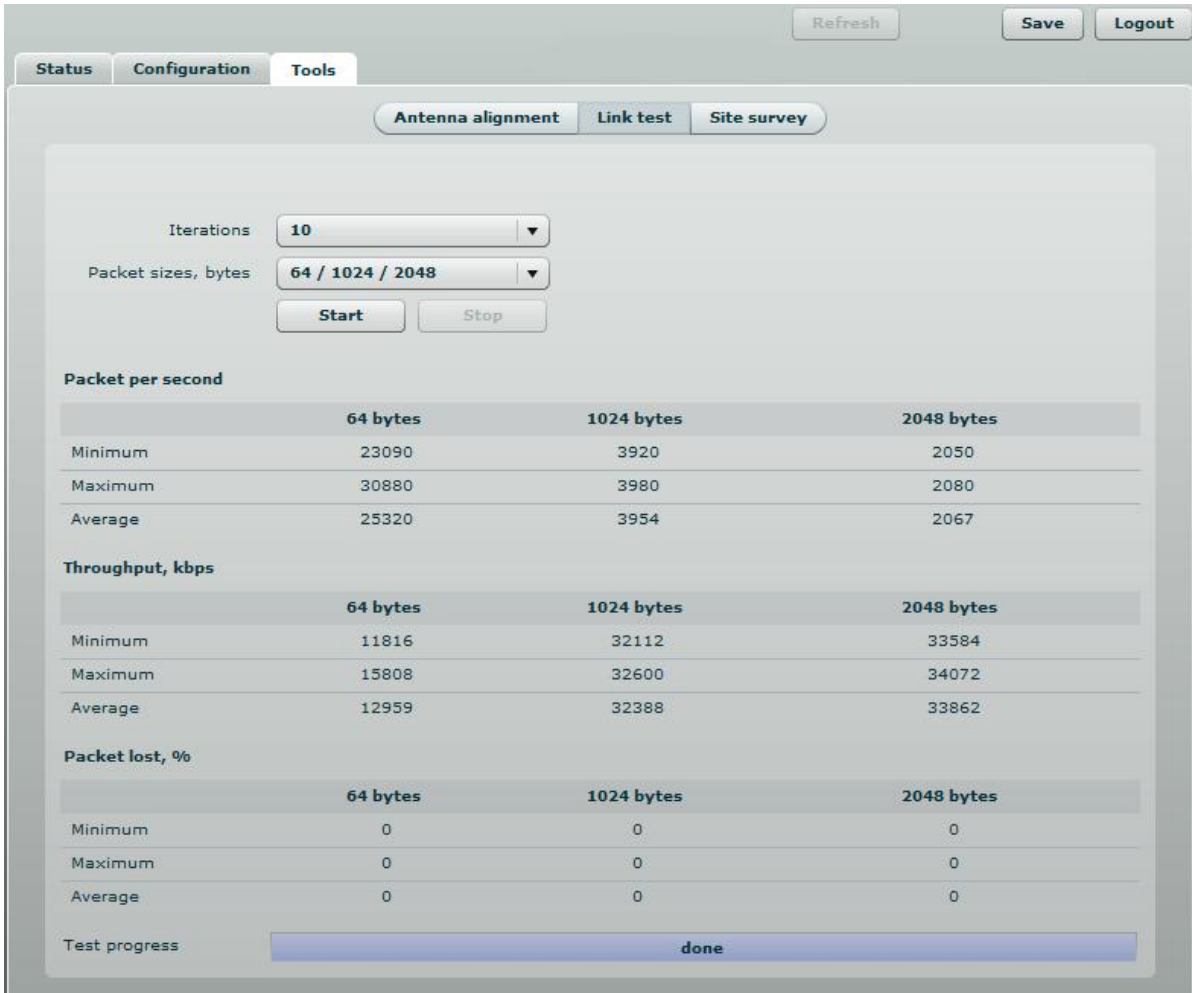

Figure 57 – Link Test Tool

Iterations – specify number of test iterations.

Packet sizes – specify packet sizes in bytes at which the test will be performed.

Start – click to start the throughput test.

Stop – click to stop the throughput test.

Logout

Click the **Logout** link on the top right corner of the main menu to leave the Web management interface:



Figure 58 – Logout Page

Logout – click to leave the PTP unit Web management.

When the **Logout** button is clicked, the administrator is redirected to the login page of the PTP unit.

OLED Control

This chapter provides information about OLED Control. Please note that this description applies for units with integrated OLED only.

OLED States

During power up the PTP unit will display its state in OLED screen:

Loading... – string being printed from the OLED display control board to indicate the moment device was powered.

Booting... – string being printed from kernel and must appear as quickly as possible after powering up the device.

Locked... – string appears after OLED has been locked and has been awakened from sleep mode. Press and hold SET button for 3 seconds to unlock the OLED. After 3 seconds the OLED notifies to release SET button, otherwise it locks again.

Sleep mode – the OLED display will be locked and the OLED screen will be turned off automatically after 5 minutes of inactivity. Press any key to activate OLED.

OLED Usage

There are 4 buttons on OLED. Two of them (MODE and SET) are functional keys; the other two keys are for navigation purpose.



Figure 59 – OLED Display

MODE – used for menu navigation.

SET – executes the particular action.

E.g. navigate to “Link test” menu using the arrow key, then press SET (S) key to enter the second level menu – throughput options by packet size. Change packet size using the MODE (M) button to 512 bytes and press the SET (S) key to execute throughput test action.

OLED Menu Structure

The 2 level OLED menu contains such functionality:

- Lock
- Alignment
- Link test
 - packet size 64
 - packet size 512
 - packet size 1024

- packet size 2048
- Statistics
 - Wireless
 - W-Jet
 - Ethernet
 - Device status
 - IP
- Reset to defaults
- Reboot



BACK menu item, located at the end of each sub-menu, returns you to the first level menu. Use an arrow keys to navigate on the Back menu and then press SET (S) key.

The following diagram represents OLED menu structure and navigation:

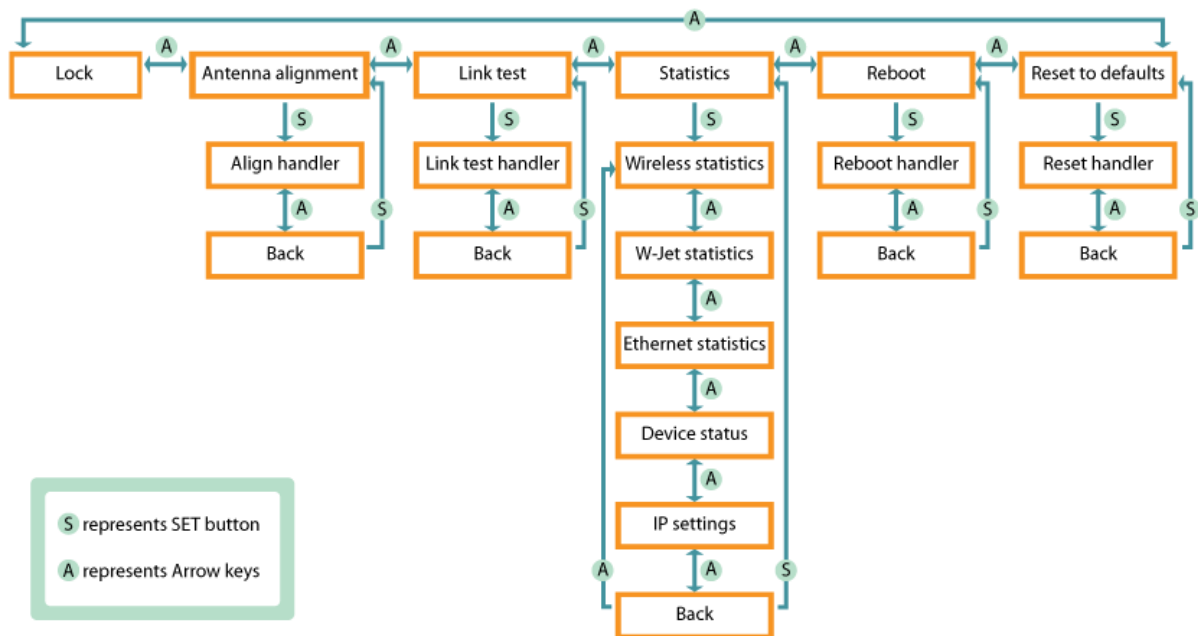

Figure 60 – Structure of the OLED Menu

OLED Functionality

If OLED is OFF it might be in a Sleep mode (press any key to wake-up) or disabled (refer at the corresponding section *OLED Control* on how to enable and set PIN code on PTP unit).

The short description of each menu screen is provided below.

Unlock the OLED

By default the OLED is locked to prevent an accidental OLED control. The OLED unlock procedure depends on either PIN code is enabled or not (refer at the corresponding section *OLED Control* on how to control OLED on PTP unit).

Press and hold SET (S) button for 3 seconds to unlock the OLED. After 3 seconds the OLED notifies to release SET button, and asks to enter a PIN code if required, otherwise it locks again. Use arrow keys to set a required number and confirm it by pressing MODE (M) key.

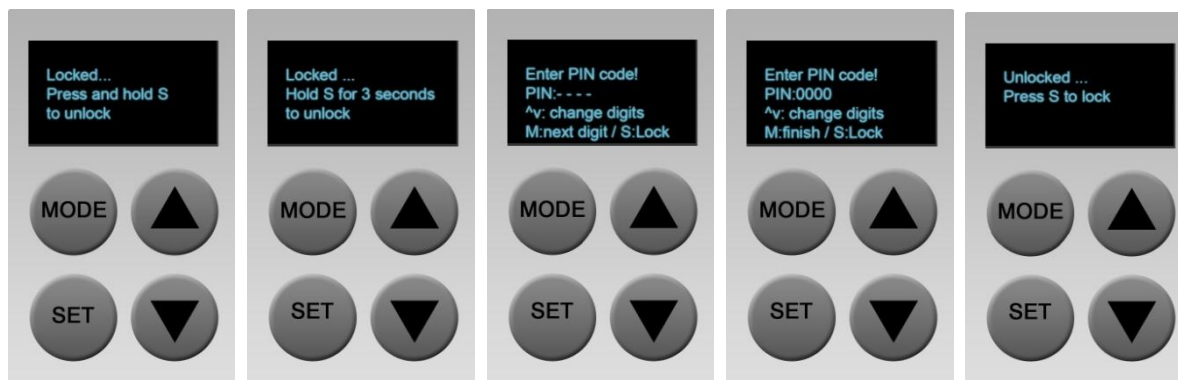

If the specified PIN code is incorrect, the user will be informed with the string “Wrong PIN”.

Run Antenna Alignment

The Antenna alignment will show RSSI (Signal strength / Noise level dBm) in numbers of both sides (where L means Local and R means Remote unit) if link is established. In case the device has 2 antennas, the information of each of them will be displayed.

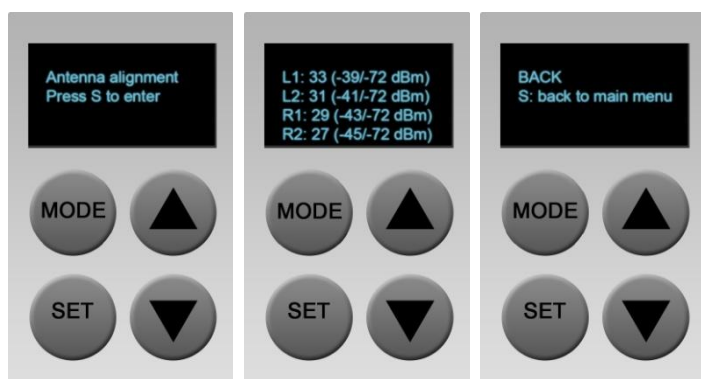

L1, L2 stands for local unit antenna 1 and antenna 2.

R1, R2 stands for remote unit antenna 1 and antenna 2.

To return to the upper level menu, use an arrow key to navigate to the Back menu and then press SET (S) key.

Run Link Test

This menu contains throughput test handlers that performs a link throughput test with the chosen packets size (64, 512, 1024, 2048 bytes). Press MODE (M) key to choose the packet size and SET (S) key to start the test. Running this test will take several seconds (progress in % is displayed while test results are loading).

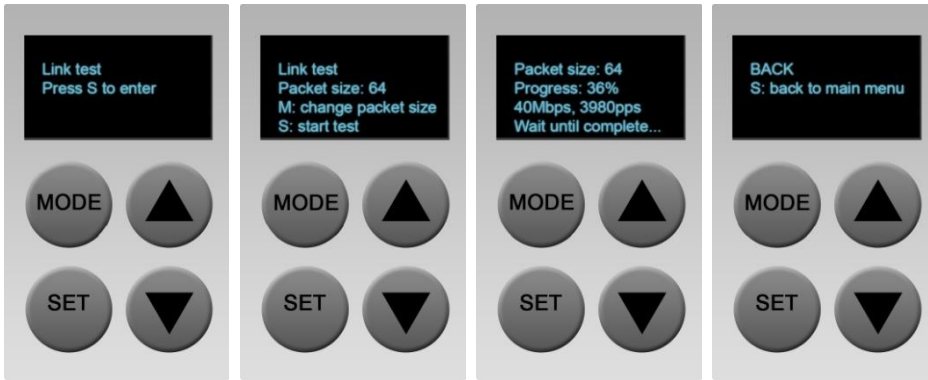

If PTP link is not established, the Link test menu displays the corresponding message “PTP connection is lost”.

To return to the upper level menu, use an arrow key to navigate to the Back menu and then press SET (S) key.

Statistics

The status menu consists of 5 submenus and the sixth Back menu to return to the upper level menu:

Wireless menu displays link wireless statistics: frequency, channel width, data rate at which the link communicates, and TX power of Local and Remote units (L/R).

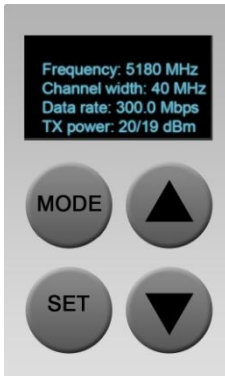

If the statistics value length is high and can't fit into the OLED's display, the value shall be divided by 10^3 , 10^6 or 10^9 and the additional letter K, M or G shall be added then (e.g. TX: 40K/234M)

If the PTP link is not established, no counters of the W-Jet statistics will be displayed, the string “---” will be shown instead (e.g. TX power: 20/--- dBm).

W-Jet menu displays Local and Remote (L/R) sides W-Jet statistics: TX (Tx packets), RX (Rx packets), Duplicated packets, and Retry count.



If the statistics value length is high and can't fit into the OLED's display, the value shall be divided by 10^3 , 10^6 or 10^9 and the additional letter K, M or G shall be added then (e.g. TX: 40K/234M)

If the PTP link is not established, no counters of the W-Jet statistics will be displayed, the string "---" will be shown instead.

Ethernet menu displays Ethernet statistics. The statistics contains information about RX and TX throughput in Mbps, RX and TX packets per second (pps), RX and TX errors per second. The Ethernet configuration is displayed in the following format:

<speed>/<duplex> <AUTO|FIXED> <link-status>", where:

<speed> is either 10, 100, 1000 (if possible);

<duplex> is FD/HD (full or half duplex);

<AUTO|FIXED> is either AUTO (auto negotiating) or FIXED (auto negotiating is disabled)

<link status> is ether "UP" or "DOWN".

The rest statistics contains info: RX and TX throughput in Mbps, RX and TX PPS (packets per

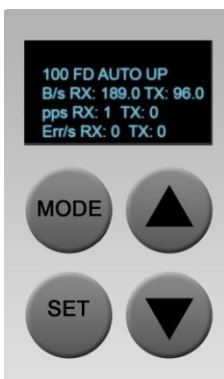

Device menu contains information about CPU load, Free memory and Firmware version:

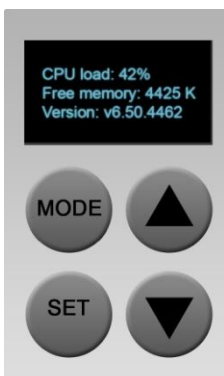

IP settings menu displays DHCP status and current IP addresses of Local and Remote units.

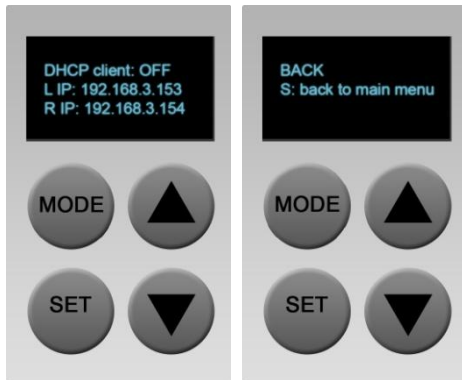

To return to the upper level menu, use an arrow key as a Back button and then press SET (S) key.

Reboot

Use this menu to reboot the PTP unit after confirmation:

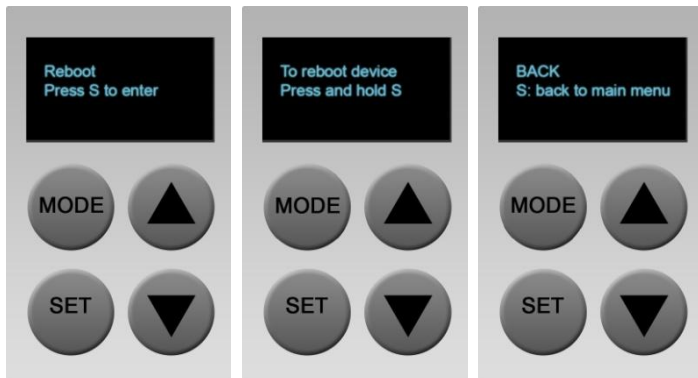

To return to the upper level menu, use an arrow key as a Back button and then press SET (S) key.

Reset to Defaults

Use this menu to reset PTP unit to factory defaults. Press SET key to start reset process.

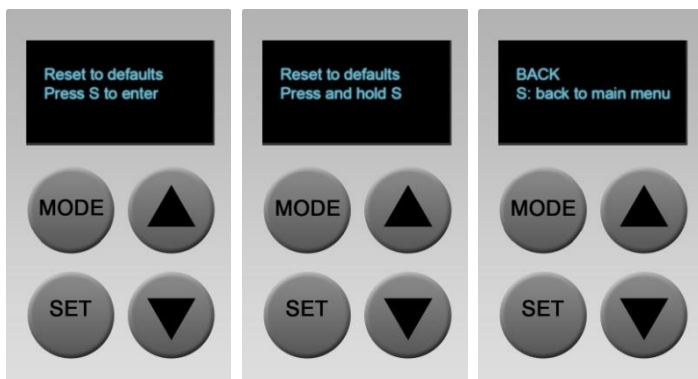

To return to the upper level menu, use an arrow key as a Back button and then press SET (S) key.



Resetting the device is an irreversible process. Current configuration, administrator password and OLED access settings will be set back to the factory default.

Lock the OLED

The OLED display will be locked and the OLED screen will be turned off automatically after 5 minutes of inactivity. To lock OLED display manually, use arrow keys to navigate on Unlocked menu and press SET (S) key.

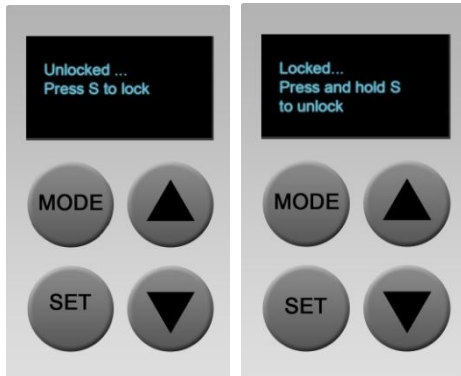

Appendix

A) Run PTP Link in Small Distance

Follow up the steps to run the PTP link for testing it in small distances (e.g. testing on a table) and achieve throughput up to 70 Mbps.

Step 1. Power-up both units: Master and Slave.

Step 2. PTP units must be placed at least a distance of 2 meters from each other.

Step 3. Change major **Radio** parameters for both units (Master and Slave):

The screenshot shows the 'Radio Settings' configuration page. The 'Configuration' tab is selected, and the 'Radio' sub-tab is active. The 'Operating mode' is set to 'Master'. Under 'Instant changes', the 'Channel width' is set to 40 MHz, 'Transmit power' is set to 5 dBm, and 'Multipath protection' is turned off. Other settings include 'Country' (UNITED STATES), 'Frequency' (5180 MHz), 'Mode' (MIMO 2x2), 'Data rate' (300 Mbps), and 'ACK timeout' (Distance). Signal strength bars for local and remote signals are shown at the bottom.

Figure 61 – Radio Settings

- **Channel width:** 40 MHz
- **Transmit power:** 5 dBm
- **Multipath protection:** off

- **Mode:** MIMO 2x2
- **Data rate:** 300 Mbps
- **ACK timeout:** Distance 0 km/miles

Click **Apply** button for configuration to take effect.

Step 4. Observe the *Signal Indicator* bar at the bottom of the screen. If it is green the quality of the link is excellent whereas the red color indicates a poor quality of the link. If results do not meet the requirements increase or decrease the Transmit Power on Radio page depending on the status of the Signal Indicator bar. The Signal must be approximately 25-30dBm.

Step 5. Start the testing: start the iperf server , then iperf client:

```

File Edit View Terminal Help
mindaugas@mindaugas-desktop:~$ iperf -c 192.168.10.124 -w 85K -M 1.0K -l 2.0M -t 102 -i 2
WARNING: attempt to set TCP maximum segment size to 1024, but got 536
-----
Client connecting to 192.168.10.124, TCP port 5001
TCP window size: 170 KByte (WARNING: requested 85.0 KByte)
-----
[ 3] local 192.168.10.1 port 43074 connected with 192.168.10.124 port 5001
[ ID] Interval      Transfer      Bandwidth
[ 3] 0.0- 2.0 sec  14.0 MBytes  58.7 Mbits/sec
[ 3] 2.0- 4.0 sec  22.0 MBytes  92.3 Mbits/sec
[ 3] 4.0- 6.0 sec  20.0 MBytes  83.9 Mbits/sec
[ 3] 6.0- 8.0 sec  22.0 MBytes  92.3 Mbits/sec
[ 3] 8.0-10.0 sec  22.0 MBytes  92.3 Mbits/sec
[ 3] 10.0-12.0 sec 20.0 MBytes  83.9 Mbits/sec
[ 3] 12.0-14.0 sec 22.0 MBytes  92.3 Mbits/sec
[ 3] 14.0-16.0 sec 20.0 MBytes  83.9 Mbits/sec
[ 3] 16.0-18.0 sec 22.0 MBytes  92.3 Mbits/sec
[ 3] 18.0-20.0 sec 22.0 MBytes  92.3 Mbits/sec
[ 3] 20.0-22.0 sec 20.0 MBytes  83.9 Mbits/sec
[ 3] 22.0-24.0 sec 20.0 MBytes  83.9 Mbits/sec
[ 3] 24.0-26.0 sec 20.0 MBytes  83.9 Mbits/sec
[ 3] 26.0-28.0 sec 20.0 MBytes  83.9 Mbits/sec
[ 3] 28.0-30.0 sec 20.0 MBytes  83.9 Mbits/sec
[ 3] 30.0-32.0 sec 20.0 MBytes  83.9 Mbits/sec
[ 3] 32.0-34.0 sec 20.0 MBytes  83.9 Mbits/sec
[ 3] 34.0-36.0 sec 20.0 MBytes  83.9 Mbits/sec
[ 3] 36.0-38.0 sec 22.0 MBytes  92.3 Mbits/sec
[ 3] 38.0-40.0 sec 16.0 MBytes  67.1 Mbits/sec
[ 3] 40.0-42.0 sec 20.0 MBytes  83.9 Mbits/sec
[ 3] 42.0-44.0 sec 18.0 MBytes  75.5 Mbits/sec
[ 3] 44.0-46.0 sec 22.0 MBytes  92.3 Mbits/sec
[ 3] 46.0-48.0 sec 20.0 MBytes  83.9 Mbits/sec
[ 3] 48.0-50.0 sec 22.0 MBytes  92.3 Mbits/sec
[ 3] 50.0-52.0 sec 20.0 MBytes  83.9 Mbits/sec
[ 3] 52.0-54.0 sec 20.0 MBytes  83.9 Mbits/sec
[ 3] 54.0-56.0 sec 20.0 MBytes  83.9 Mbits/sec
[ 3] 56.0-58.0 sec 22.0 MBytes  92.3 Mbits/sec
[ 3] 58.0-60.0 sec 22.0 MBytes  92.3 Mbits/sec
[ 3] 60.0-62.0 sec 20.0 MBytes  83.9 Mbits/sec
[ 3] 62.0-64.0 sec 22.0 MBytes  92.3 Mbits/sec
[ 3] 64.0-66.0 sec 22.0 MBytes  92.3 Mbits/sec
[ 3] 66.0-68.0 sec 22.0 MBytes  92.3 Mbits/sec
[ 3] 68.0-70.0 sec 22.0 MBytes  92.3 Mbits/sec
[ 3] 70.0-72.0 sec 20.0 MBytes  83.9 Mbits/sec
[ 3] 72.0-74.0 sec 22.0 MBytes  92.3 Mbits/sec
[ 3] 74.0-76.0 sec 22.0 MBytes  92.3 Mbits/sec
[ 3] 76.0-78.0 sec 22.0 MBytes  92.3 Mbits/sec
[ 3] 78.0-80.0 sec 20.0 MBytes  83.9 Mbits/sec
[ 3] 80.0-82.0 sec 22.0 MBytes  92.3 Mbits/sec
[ 3] 82.0-84.0 sec 22.0 MBytes  92.3 Mbits/sec
[ 3] 84.0-86.0 sec 22.0 MBytes  92.3 Mbits/sec
[ 3] 86.0-88.0 sec 20.0 MBytes  83.9 Mbits/sec
[ 3] 88.0-90.0 sec 22.0 MBytes  92.3 Mbits/sec
[ 3] 90.0-92.0 sec 20.0 MBytes  83.9 Mbits/sec
[ 3] 92.0-94.0 sec 22.0 MBytes  92.3 Mbits/sec

```

Figure 62 – iperf Results (TCP)

```

File Edit View Terminal Help
mindaugas@mindaugas-desktop:~$ iperf -c 192.168.10.1 -u -b 95M -t 38 -i 2 -d -w 110k
-----
Server listening on UDP port 5001
Receiving 1470 byte datagrams
UDP buffer size: 220 KByte (WARNING: requested 110 KByte)
-----
Client connecting to 192.168.10.1, UDP port 5001
Sending 1470 byte datagrams
UDP buffer size: 220 KByte (WARNING: requested 110 KByte)
-----
[ 4] local 192.168.10.1 port 46203 connected with 192.168.10.1 port 5001
[ 3] local 192.168.10.1 port 5001 connected with 192.168.10.1 port 46203
[ ID] Interval      Transfer      Bandwidth
[ 4] 0.0- 2.0 sec  22.8 MBytes  95.6 Mbits/sec
[ 3] 0.0- 2.0 sec  22.8 MBytes  95.6 Mbits/sec  0.006 ms  0/16260 (0%)
[ 4] 2.0- 4.0 sec  22.8 MBytes  95.6 Mbits/sec
[ 3] 2.0- 4.0 sec  22.8 MBytes  95.6 Mbits/sec  0.000 ms  0/16260 (0%)
[ 4] 4.0- 6.0 sec  22.8 MBytes  95.6 Mbits/sec
[ 3] 4.0- 6.0 sec  22.8 MBytes  95.6 Mbits/sec  0.000 ms  0/16260 (0%)
[ 4] 6.0- 8.0 sec  22.8 MBytes  95.6 Mbits/sec
[ 3] 6.0- 8.0 sec  22.7 MBytes  95.1 Mbits/sec  0.001 ms  86/16260 (0.53%)
[ 4] 8.0-10.0 sec  22.8 MBytes  95.6 Mbits/sec
[ 3] 8.0-10.0 sec  22.8 MBytes  95.6 Mbits/sec  0.001 ms  0/16261 (0%)
[ 4] 10.0-12.0 sec 22.8 MBytes  95.6 Mbits/sec
[ 3] 10.0-12.0 sec 22.8 MBytes  95.6 Mbits/sec  0.002 ms  0/16260 (0%)
[ 4] 12.0-14.0 sec 22.8 MBytes  95.6 Mbits/sec
[ 3] 12.0-14.0 sec 22.8 MBytes  95.6 Mbits/sec  0.003 ms  0/16260 (0%)
[ 4] 14.0-16.0 sec 22.8 MBytes  95.6 Mbits/sec
[ 3] 14.0-16.0 sec 22.8 MBytes  95.6 Mbits/sec  0.000 ms  0/16260 (0%)
[ 4] 16.0-18.0 sec 22.8 MBytes  95.6 Mbits/sec
[ 3] 16.0-18.0 sec 22.7 MBytes  95.1 Mbits/sec  0.001 ms  88/16260 (0.54%)
[ 4] 18.0-20.0 sec 22.8 MBytes  95.6 Mbits/sec
[ 3] 18.0-20.0 sec 22.7 MBytes  95.0 Mbits/sec  0.001 ms  101/16260 (0.62%)
[ 4] 20.0-22.0 sec 22.8 MBytes  95.6 Mbits/sec
[ 3] 20.0-22.0 sec 22.7 MBytes  95.0 Mbits/sec  0.000 ms  101/16261 (0.62%)
[ 4] 22.0-24.0 sec 22.8 MBytes  95.6 Mbits/sec
[ 3] 22.0-24.0 sec 22.8 MBytes  95.6 Mbits/sec  0.004 ms  0/16260 (0%)
[ 4] 24.0-26.0 sec 22.8 MBytes  95.6 Mbits/sec
[ 3] 24.0-26.0 sec 22.8 MBytes  95.6 Mbits/sec  0.001 ms  0/16260 (0%)
[ 4] 26.0-28.0 sec 22.8 MBytes  95.6 Mbits/sec
[ 3] 26.0-28.0 sec 22.8 MBytes  95.6 Mbits/sec  0.000 ms  0/16260 (0%)
[ 4] 28.0-30.0 sec 22.8 MBytes  95.6 Mbits/sec
[ 3] 28.0-30.0 sec 22.8 MBytes  95.6 Mbits/sec  0.001 ms  0/16260 (0%)
[ 4] 30.0-32.0 sec 22.8 MBytes  95.6 Mbits/sec
[ 3] 30.0-32.0 sec 22.8 MBytes  95.6 Mbits/sec  0.000 ms  0/16260 (0%)
[ 4] 32.0-34.0 sec 22.8 MBytes  95.6 Mbits/sec
[ 3] 32.0-34.0 sec 22.8 MBytes  95.6 Mbits/sec  0.001 ms  0/16261 (0%)
[ 4] 34.0-36.0 sec 22.8 MBytes  95.6 Mbits/sec
[ 3] 34.0-36.0 sec 22.8 MBytes  95.6 Mbits/sec  0.001 ms  0/16260 (0%)
[ 4] 36.0-38.0 sec 22.8 MBytes  95.6 Mbits/sec
[ 4] 0.0-38.0 sec 433 MBytes  95.6 Mbits/sec
[ 4] Sent 308944 datagrams
[ 3] 36.0-38.0 sec 22.8 MBytes  95.6 Mbits/sec  0.000 ms  0/16260 (0%)

```

Figure 63– iperf Results (UDP)

Step 6. If the result meets the requirements, before mounting PTP units outside, increase the Transmit Power.

B) Resetting Unit to Factory Defaults

PTP units have the capability of being reset to defaults by pinging the device with a certain packet size when the radio is booting. During the startup of the device, when the drivers of the ethernet interfaces are loaded, the discovery daemon is started. The daemon suspends startup process for 3 seconds and waits for ICMP "echo request" packet of length 369 bytes. If the packet received, the discoveryd resets the device to default configuration.



It is recommended to connect PC to the device via switch, as depending on PC OS settings, the ARP table might be flushed during wired link status change (connecting the device that will be reset).

Steps to reset to default settings:

Step 1. Power off the device.

Step 2. Obtain the device MAC address.

Step 3. Connect a PC to the same physical subnet as the device.

Step 4. Execute 'arp -s' command to assign the IP address (IP address should be from the same subnet as PC) to the device MAC address:

```
arp -s <IP address to assign> <device MAC address>
```



Note that syntax of MAC address differs depending on OS:

- Linux OS: AA:BB:CC:DD:EE:FF
- Windows OS: AA-BB-CC-DD-EE-FF

Step 5. Start pinging the device:

For Linux users: ping <IP address> -s 369

For Windows users: ping <IP address> -l 369 -t -w 0.2

Step 6. Power up device and wait about 30sec or more (depending on device hardware).

Step 7. Stop pinging the device, and let the device boot as usual. The device should start up with factory default settings.

Index

A

- administrator password, 37
- AES encryption, 34
- antenna alignment, 20, 22, 44
- antenna mode
 - MIMO, 34
 - SISO, 34

C

- configuration file
 - backup, 41
 - restore, 41

D

- data transmission rates, 34
- default login settings, 12, 13
- DNS server, 32

E

- encryption, 16
- Ethernet link duplex, 32
- Ethernet link speed, 32

F

- firmware upgrade, 43

G

- GMT time, 36
- graphic diagram, 29
 - CPU load, 31
 - frequency, 31
 - memory, 30
 - RSSI, 29
 - RX/TX errors, 30
 - traffic, 30
- grounding, 20

I

- instant changes, 23

L

- Link ID, 14, 33
- link test, 45
- local unit, 7, 28, 29
- logout, 47

M

- management VLAN, 32
- mounting, 20
 - on a large pipes, 21
 - on a small pipe, 21
 - on a wall, 21
- mounting bolts, 21
- mounting brackets, 21

N

- NTP, 35

O

- OLED, 11, 22
 - functionality, 49
 - menu, 48
 - navigation, 48
 - states, 48
- OLED control, 48
- operating mode, 13
 - master, 7, 33
 - slave, 7, 33

P

- PTP protocol, 9, 28

R

- reboot, 41
- remote unit, 7, 28, 29
- reset to factory default, 41

S

- signal indicator, 18, 24, 56
- site survey, 44
- SMTP, 40
- SNMP, 38
 - traps, 40
 - v1, v2c, 38
 - v3, 38
- statistics, 28
 - w-jet, 28
- status, 26
 - network, 27
 - system, 26
 - wireless, 27
- system alerts, 39
 - SMTP, 40
 - SNMP Traps, 40
- system log, 37

view, 41

T

timezone, 36

troubleshooting file, 41

W

WNMS, 39